

## Setup PAGES

Display	<b>diSP</b>	Output #1	<b>Out1</b>
Control	<b>Ctrl</b>	Output #2	<b>Out2</b>
Input	<b>InPt</b>	Output #3	<b>Out3</b>
Ramp/Soak	<b>rSPg</b>	Output #4	<b>Out4</b>
Custom Input Output Scaling	<b>ScAl</b>	Output #5	<b>Out5</b>
		Digital Communications	<b>di9</b>

### rSPg PAGE

This setup PAGE appears only if Ramp/Soak control is turned on. The Ramp/Soak Enable parameter is the next to the last menu on Ctrl PAGE, Menu rSEn.

## Ramp/Soak Page

MENU	Description	Available Settings
<b>unit</b>	Time Units	SEc = seconds (1 to 9999) min = minutes (0.1 to 999.9) hr = hours (0.01 to 99.99)
<b>Stby</b>	Standby Setpoint	Instrument Sensor Span
<b>int1</b>	Interval 1 Time	see Time Units Menu (above)
<b>SP1</b>	Setpoint 1	Instrument Sensor Span
		Intervals 2-16
		Time and Setpoint
<b>Cont</b>	Continuous	OFF, On
<b>Fro</b>	Loop from the end of interval	1 to 16
<b>to</b>	To the beginning of interval	1 to 16
<b>no</b>	Number of times	0 to 9999
<b>SbEt</b>	Standby Events	OFF = All off E3 = Event Output 3 On E4 = Event Output 4 On E43 = Event Outputs 4 & 3 On E5 = Event Output 5 On E53 = Event Outputs 5 & 3 On E54 = Event Outputs 5 & 4 On E543 = Event Outputs 5, 4, 3 On
<b>ilE</b>	Interval 1-16 Events	same as above for Stand by Events
<b>GSdb</b>	Guaranteed Soak Differential	OFF, 1°F to sensor range

## Front Panel Identification

- Process Variable Display in Normal Display Mode
- Alphanumeric Cue Display in Setup Mode

- LEDs indicate Control Output #1 or #2 ON
- LEDs indicate Alarm or Event Output ON
- LED indicates an Auxiliary function is active
- LEDs indicate °F or °C selected for Process Variable



- RESET** Pushbutton
  - Reset Latching Alarm
  - Hold for more than 3 seconds to enter or exit Setup Mode
  - Scrolls through MENUS in Setup Mode
- AUX** Programmable Pushbutton
  - PID1/PID2 Toggle Switch
  - Auxiliary Setpoint Enable
  - Remote Setpoint Enable
  - Output Disable
  - Ramp/Soak Operations
  - Auto/Manual Selector
- Active Setpoint Display
  - In Normal Display Mode, pushbuttons adjust Setpoint.
  - In Setup Mode, pushbuttons increase/decrease MENU values.
  - For Ramp/soak Operation:
    - ▲ Start
    - ▼ Hold
    - ▲ } Press together to Stop
    - ▼

## To enter Setup Mode:

Hold down the RESET pushbutton for longer than 3 seconds.

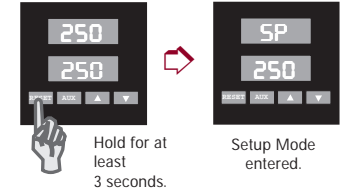

## To select a PAGE:

Press and hold the Reset pushbutton, while pressing the ▲ or ▼ Pushbutton.

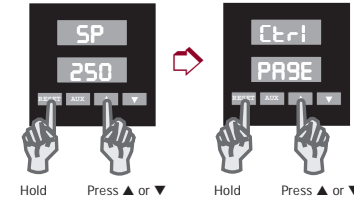

## To select a MENU:

After reaching the correct PAGE, press RESET to move through the MENUS.

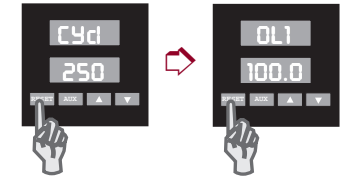

## To change a MENU value:

After the MENU is selected and displayed, use the ▲ and ▼ pushbuttons to change the value.

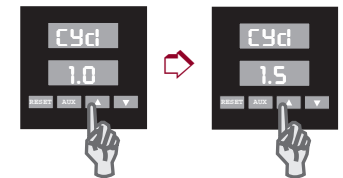

## To return to Operating Mode:

Press and hold RESET for more than 3 seconds.



## Ctrl PAGE

### Control Page

MENU	Description	Available Settings
<b>LocH</b>	Security Lock	0 to 9999
<b>SP</b>	Setpoint	Instrument sensor span
<b>RuSP</b>	Auxiliary SP	Instrument sensor span
<b>tunE</b>	Self Tune	OFF = Self-tuning disabled PrUP = Power-up tuning BEgn = Begin tuning
<b>Pb1</b>	Proportional Band 1	0°F to sensor range 0°F displays as 0.00°F to indicate ON/OFF control
<b>Rr1</b>	Automatic Reset 1	0.00 to 99.99 repeats/minute
<b>rRt1</b>	Rate 1	0 to 500 seconds
<b>db1</b>	Dead Band 1	1 to 100°F, 0.01 to 6.25% span for analog inputs
<b>Pb2</b>	Proportional Band 2	0°F to sensor range 0°F displays as 0.00°F to indicate ON/OFF control
<b>Rr2</b>	Automatic Reset 2	0.00 to 99.99 repeats/minute
<b>rRt2</b>	Rate 2	0 to 500 seconds
<b>db2</b>	Dead Band 2	1 to 100°F, 0.01 to 6.25% span for analog inputs
<b>QFSr</b>	Manual Reset	-99.9 to 99.9
<b>FL</b>	Fuzzy Logic	OFF, On
<b>Grn9</b>	Open Sensor Output Command	-100.0 to -0.1 for cooling 0.1 to 100.0 for heating
<b>Loop</b>	Control Loop Protection	OFF, 0.1 to 999.9 minutes
<b>Auto</b>	Auto/Manual Disintegration time	0 to 100 seconds
<b>rRt</b>	Ramp Rate	OFF or 1 to 9999 degrees/hour
<b>Cont</b>	Controller Type	HERt = Reverse Acting Single Output CoOL = Direct Acting Single Output HEt = Heat/Cool
<b>CoOL</b>	Cooling Medium	PId2 = Uses PID2 settings for cooling Air = Air Cooling Oil = Oil Cooling H2O = Water Cooling

### Control Page (continued)

MENU	Description	Available Settings
<b>rSP</b>	Remote Setpoint Enable	OFF, On
<b>Ent</b>	Event/Digital Input Function	nonE = Disabled Pid2 = PID2 enable RuSP = Auxiliary SP enable rSP = Remote SP enable Outd = Output disable rS = Ramp/Soak Auto = Auto/Manual Ri r = Alarm Reset
<b>Ru</b>	Auxiliary Key Function	nonE = Disabled Pid2 = PID2 enable RuSP = Auxiliary SP enable rSP = Remote SP enable Outd = Output disable Auto = Auto/Manual
<b>Rout</b>	Analog Output Assignment	nonE = Disabled Proc = Process Variable RSP = Active Setpoint Out1 = Control Output 1 Out2 = Control Output 2
<b>rSEn</b>	Ramp/Soak	OFF, On

## InPt PAGE

### Input Page

MENU	Description	Available Settings
<b>SEnS</b>	Sensor Type	J = J T/C K = K T/C T = T T/C E = E T/C R = R T/C S = S T/C B = B T/C rtd = 100Ω RTD (α = .00385) 4-20 = 4-20mA 0-5 = 0-5 Vdc 1-5 = 1 t-5 Vdc rtdt = 100Ω RTD (0.1° Resolution)
<b>unit</b>	Display Units	nonE = no units °F = Fahrenheit °C = Celsius
<b>CoFF</b>	Calibration Offset	0 to ±100°F
<b>SPLL</b>	Setpoint Low Limit	Instrument Sensor Span
<b>SPUL</b>	Setpoint Upper Limit	Instrument Sensor Span
<b>Flt</b>	Digital Filter	0 to 60 Seconds
<b>hPrC</b>	High Process Input	Instrument Sensor Span
<b>LPrc</b>	Low Process Input	Instrument Sensor Span
<b>hA</b>	High Ambient Temp.	Instrument Sensor Span
<b>LoA</b>	Low Ambient Temp.	Instrument Sensor Span

## Out PAGE

### Outputs #1 and #2

MENU	Description	Available Settings
<b>Cyc1</b>	Output #1 Cycle Time	0.0 to 60.0 seconds 0.0 = Voltage/Current algorithm
<b>OL1</b>	Output #1 Limit	0.0 to 100.0%
<b>HoFF</b>	Heat Offset	0°F to PB1 setting

## Out3 PAGE

These setup PAGES appear only if the controller is equipped with Outputs #3, #4 and #5.

### Outputs #3, #4 and #5

MENU	Description	Available Settings
<b>tYP3</b>	Output #3 Type	OFF = Disabled Ri r = Alarm Output Ent = Event Output
<b>Ri r3</b>	Alarm #3 Type	nonE = Disabled (off) Hi = High Alarm Lo = Low Alarm HiLo = High-Low Alarm PdE = + Dev Alarm -dE = - Dev Alarm dE = +/- Dev Alarm LoSP = Control Loop Protection Alarm
<b>rLY3</b>	Alarm #3 Relay Action	ndE = Normally de-energized non-latching nE = Normally energized non-latching ndEL = Normally de-energized latching nEL = Normally energized latching
<b>ALo3</b>	Alarm #3 Low SP	Instrument Sensor Span
<b>AHi3</b>	Alarm #3 High SP	Instrument Sensor Span
<b>db3</b>	Output #3 Dead Band (Alarm Hysteresis)	0 to 100°F
<b>inh3</b>	Alarm #3 Inhibit	OFF On

# 2104

# Chromalox<sup>®</sup>

Temperature Controller



Issue Date  
May 1996

Technical Manual  
0037-75276

# Table of Contents ---

## **Sections**

<b><u>Section</u></b>	<b><u>Topic</u></b>	<b><u>Page</u></b>
1	Getting Started .....	1
2	Installation .....	3
3	Operation .....	21
4	Controller Setup Pages .....	33
5	Ramp/Soak Operation .....	41
6	Alarms .....	47
7	Digital Input and AUX Function .....	59
8	Remote Setpoint & Analog Process Output .....	67
9	Digital Communications .....	71
10	Calibration .....	75
11	Specifications .....	83
12	Troubleshooting .....	87
13	Warranty and Return .....	89

## **Appendices**

I	Setup Pages .....	91
---	-------------------	----

## **Menu Index**

Index .....	103
-------------	-----

## Illustrations

<u>Figure</u>	<u>Topic</u>	<u>Page</u>
1.1	Application .....	1
1.2	Model Identification.....	2
2.1	Sensor Selection Dip Switch Settings .....	3
2.2	Mounting Dimensions .....	5
2.3	Mounting Diagram .....	5
2.4	Wiring Terminal Identification .....	7
2.5	Thermocouple Connections.....	8
2.6	3-Wire RTD Connections .....	9
2.7	2-Wire Connections .....	9
2.8	Current Input Wiring (Self-powered) .....	9
2.9	Voltage Input Wiring.....	10
2.10	Current Input Wiring (Loop-power) .....	10
2.11	Event Input Connections External Switch.....	10
2.12	Momentary Contact Pushbutton for Ramp/Soak ..	10
2.13	Relay Output Connections .....	11
2.14	SSR Drive Output Jumper Positions .....	12
2.15	Solid State Relay Drive Output Connections .....	13
2.16	Current/Voltage Output Jumper Positions.....	14
2.17	Triac Output Connections .....	15
2.18	4-20mA Analog Output Connections .....	15
2.19	1-5 Vdc Output Connections .....	15
2.20	Dual Relay Output Wiring .....	16
2.21	Dual Triac Output Wiring .....	16
2.22	Dual Analog Output Wiring .....	16
2.23	Dual SSR Drive Output Wiring .....	16
2.24	Dual 1-5 Vdc Output Wiring .....	17

## Illustrations

<b>Figure</b>	<b>Topic</b>	<b>Page</b>
2.25	Dual Output SSR/Relay Wiring .....	17
2.26	Dual Output SSR/Triac Wiring .....	17
2.27	Dual Output Analog/Relay Wiring .....	18
2.28	Dual Output Analog/Triac Wiring .....	18
2.29	100-240 Vac Instrument Power Connections .....	19
2.30	12-24 Vac/Vdc Instrument Power Connections ...	19
2.31	Alarm/Event Outputs #3 and #4 .....	19
2.32	Alarm/Event Output #5 .....	20
3.1	Front Panel Identification .....	22
3.2	PAGE/MENU Setup Structure .....	23
3.3	Sample of PAGE/MENU Table .....	25
3.4	Security Levels and PAGE/MENU Contents .....	26
3.5	Security Codes and View/Adjust Levels .....	27
5.1	Ramp/Soak Profile .....	41
5.2	Event Outputs in Ramp/Soak Profile .....	41
5.3	Looping Intervals .....	42
5.4	Guaranteed Soak .....	42
6.1	CLP Alarm Connections .....	55
8.1	Remote Setpoint Input Signal .....	67
8.2	2-Wire 4-20mA Transmitter (Loop-powered) .....	68
8.3	2-Wire 4-20mA, 1-5 Vdc Transmitter (Self-powered) ...	68
8.4	3-Wire 4-20mA, 1-5 Vdc Transmitter .....	68
8.5	Analog Process Output Signal .....	69
8.6	Process Output Wiring .....	70
9.1	RS422/RS485 Communications Switches .....	72
9.2	RS232 Wiring Connections .....	72
9.3	RS422A Wiring Connections (4-wire) .....	73
9.4	RS485 Wiring Connections (2-wire) .....	73



# Section 1 Getting Started

The Chromalox 2104 1/4 DIN temperature and process controller is a low-cost, high-performance, single-loop controller that can be used for temperature, flow, pressure and level control applications. With universal sensor inputs and front panel operator setup, one 2104 controller can be easily field configured for a wide variety of applications, and simply reconfigured as application needs change. This makes it an exceptional choice for OEMs with multiple control needs, manufacturing facilities, testing facilities and testing applications.

Figure 1.1  
Typical Application

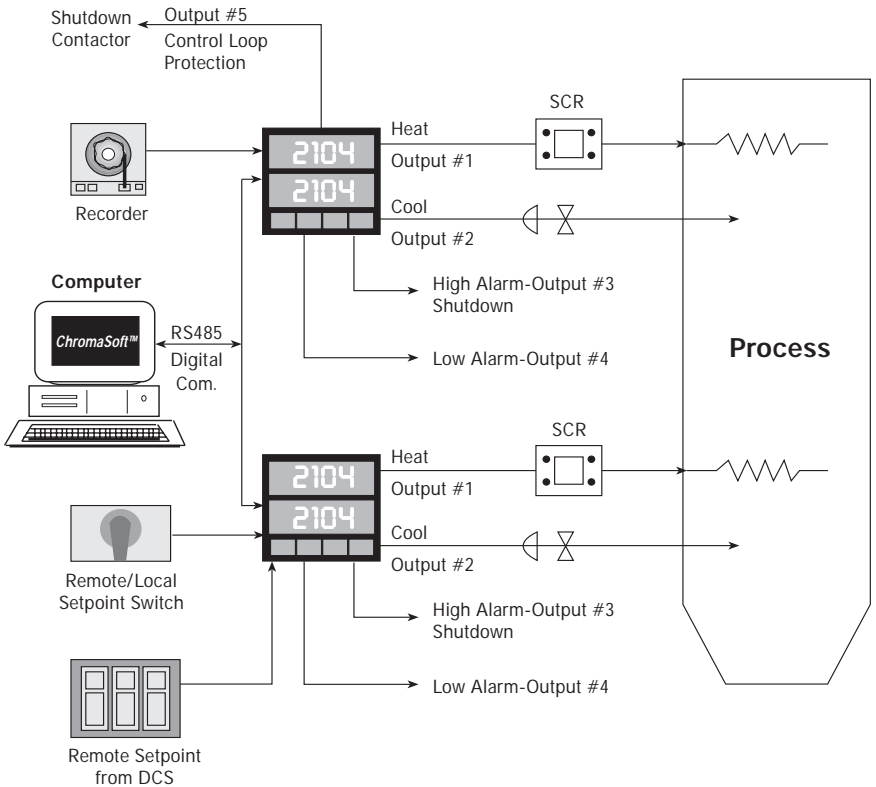

## Model Identification

Before installation, please identify your controller model number. The model number is written on the tag on the side of the housing.

Figure 1.2 Model Identification

Model	Temperature Controller				
2104	Microprocessor-based 1/4 DIN Temperature Controller. Universal Sensor Input accepts Thermocouple, RTD, Current or Voltage Inputs. PID, ON/OFF with Fuzzy Logic Control Capability. One Digital Input and Analog Remote Set Point.				
	<b>Code</b>	<b>Outputs #1—Single Output Control</b>			
	RO	Output #1 Single Output Control Relay/SSR Drive (jumper selectable) Relay—N.O. Form A Contact, 1A at 120 or 230 Vac SSR Drive—24Vdc at 40mA			
	TO	Triac—1 Amp at 120 or 230 Vac			
	AO	Analog—4-20mA or 1-5 Vdc, non-isolated			
		<b>Outputs #1 &amp; #2 - Heat/Cool Control</b>			
	RR	Relay/Relay			
	TT	Triac/Triac			
	AA	Analog/Analog			
	SS	SSR Drive/SSR Drive			
	AR	Analog/Relay			
	AT	Analog/Triac			
	SR	SSR Drive/Relay			
	ST	SSR Drive/Triac			
		<b>Code</b>	<b>Outputs #3 &amp; #4 (Alarm/Event Outputs)</b>		
		0	None		
		1	Dual Relay—Two (2) Form A contacts, 1A at 120 or 230 Vac with shared common terminal		
			<b>Code</b>	<b>Isolated Digital Communications, Output #5 (Alarm/Event Output), and Analog Output Option</b>	
			0	None	
			1	RS-422/485 Digital Communications and Output #5	
			2	RS-232 Digital Communications and Output #5	
			3	Analog Output Option	
			4	RS-422/485 Digital Communications, Output #5 and Analog Output Option	
			5	RS-232 Digital Communications, Output #5 and Analog Output Option	
			<b>Code</b>	<b>Power Supply</b>	
			0	100 - 240 Vac or Vdc	
			1	12-24 Vdc or Vac	
2104-	RO	1	1	0	Typical Model Number

**Inspection  
and  
Unpacking**

On receipt of your 2104 controller, immediately make note of any visible damage to the shipment packaging and record this damage on the shipping documents. Unpack the controller and carefully inspect it for obvious damage due to shipment. If any damage has occurred, YOU must file a claim with the transporter, as they will not accept a claim from the shipper.

If the controller will not be immediately installed and placed into operation, it should be stored in a cool, dry environment in its original protective packaging until time for installation and operation. Temperature extremes and excessive moisture can damage the instrument.

**Switch  
Settings**

The 2104 has up to seven (7) hardware switches located on the bottom of the controller. The switches are accessible through cutouts in the controller housing and do not require that you remove the controller from its housing to access the switches.

Figure 2.1 identifies the switches. Instructions for switch settings are given in the corresponding sections of the manual.

Figure 2.1  
Sensor Selection  
Dip Switch  
Settings

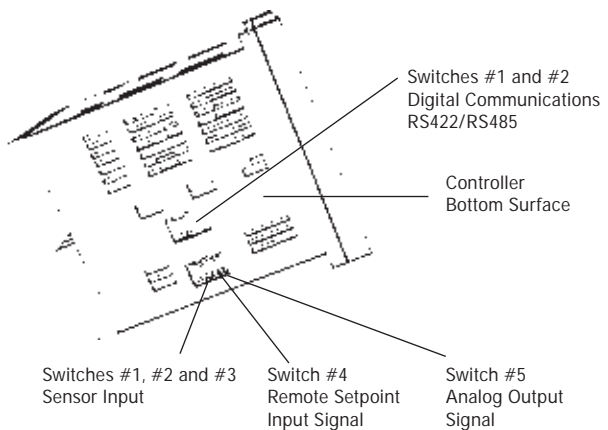

## Sensor Selection Switches

Sensor selection requires that you:

1. Set the sensor switches for the correct sensor type.
2. Program the input sensor type in sensor selection setup on the  $\mu$ PC Page (see page 36).

**It is much easier to set the sensor input switches before you mount and wire the controller.**

To set the sensor switches:

1. Locate the sensor switches—#1, #2 and #3—on the bottom of the controller, as shown in Figure 2.1 on the previous page.
2. Place the switches in the appropriate Up or Down position for your input type:

Input Type	Switch #		
	1	2	3
T/C	Up	Up	Up
RTD	Down	Up	Up
4-20mA	Up	Down	Down
1-5 Vdc	Up	Up	Down

## Mounting

Figure 2.2, on the following page, shows the mounting dimensions for the controller:

1. Cut out the square “panel cutout” mounting hole and install the unit as shown in Figure 2.3.
2. Place the controller through the square panel cutout and replace the mounting clip.
3. Tighten the mounting clip screw (do not over-tighten) to secure the controller firmly against the mounting surface.

Figure 2.2 Mounting Dimensions

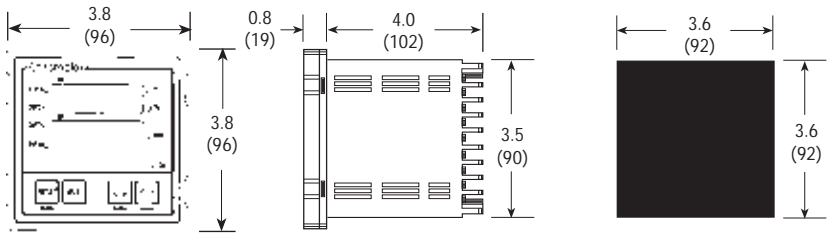

Measurements are shown in inches. Millimeters are shown in parentheses.

Figure 2.3 Mounting Diagram

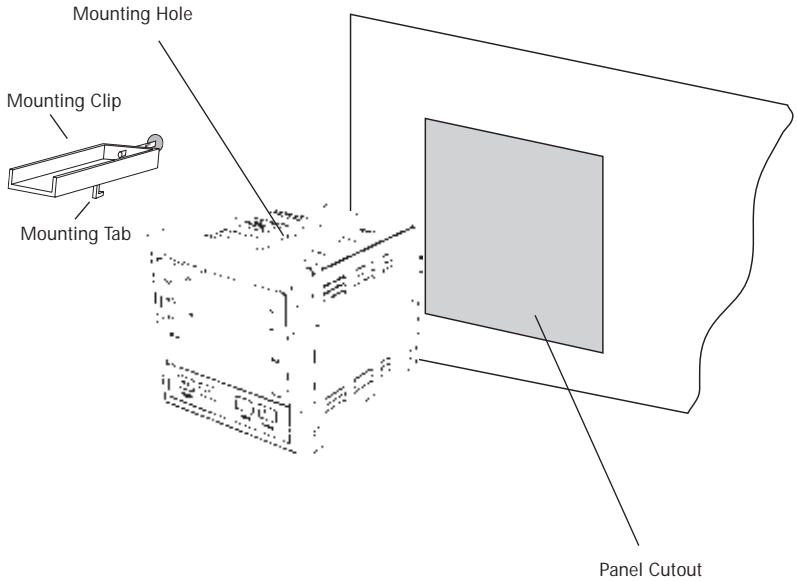

## **Wiring Instructions**

### **Good Wiring Practices**

1. When planning the system wiring, separate wiring into functionally similar bundles - i.e., power leads, sensor leads, output signal lines, etc. If the power leads and sensor leads must cross, they should cross at a 90° angle to each other (perpendicular).
2. Locate all sources of electrical noise in your system, and separate these sources from the control systems—motors, contacts, solenoids, etc. Electrical noise can affect the function of any control system. When driving a contactor coil or other inductive load, an appropriately rated AC snubber circuit is recommended (Chromalox Part. No. 0149-01305), as described on page 11, “Relay Output Wiring.”
3. For sensor wiring practices, see Sensor Wiring Notes, next page.
4. Additional information on good wiring practices is available from IEEE, 345 East 47th St., NY, NY 10017. Request IEEE Standard No. 518-1982.

Make all electrical wiring connections to the back of the controller before power is applied to the unit.

All wiring must comply with local codes, regulations and ordinances. This instrument is intended for panel mounting and the terminals must be enclosed within a panel. Use National Electric Code (NEC) Class 1 wiring for all terminals except the sensor terminals.

Check the wiring decal on the side of the unit to verify the model number. The wiring decal shows the wiring terminations. All wires will be connected to the terminals on the back of the instrument case. Specific wiring instructions for different input and output types are given in this section.

Figure 2.4 Wiring Terminal Identification

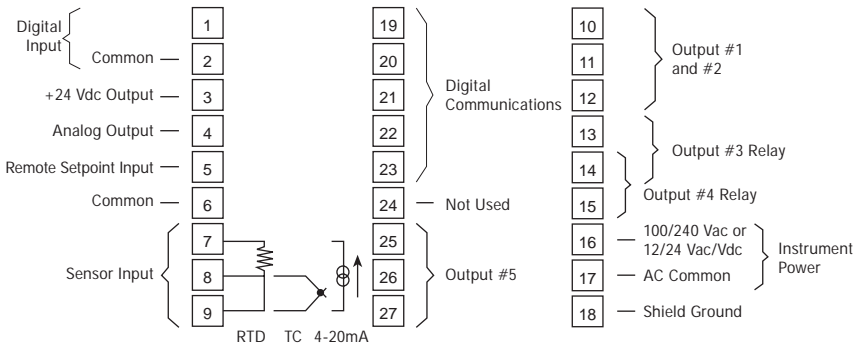

## Sensor Input Wiring

### Sensor Input Wiring Notes:

- Sensor leads (thermocouple and RTD) should not be run together in the same conduit as power wiring.
- Twisted pair, shielded wire is recommended for sensor connections.
- False process readings can occur if the sensor wire is exposed to electrical noise.
- Ungrounded thermocouples are recommended.
- If thermocouple extension wire is required, it must be the same type as the thermocouple (i.e., if a Type K thermocouple is used, then Type K extension wire must be used).
- Thermocouple wires should connect directly to the controller terminals. Do not use copper crimp terminals or solder terminals to make connections.
- If shielded thermocouple wire is used, the shield must be grounded at one end only, preferably at the shield ground terminal on the controller, as shown in Figure 2.5.
- Three wire RTDs are recommended for greatest accuracy.
- Standard shielded copper wire is recommended for RTD extensions.

### Thermocouple Inputs

It is important to observe polarity (+, -) when connecting thermocouple leadwires. The table below shows ANSI color coding for the thermocouples used with this instrument.

T/C Type	Material	Polarity (+)	Polarity (-)
B	Plat, 30% Rhodium/ Plat, 6% Rhodium	Gray	Red
J	Iron/Constantan	White	Red
K	Chromel/Alumel	Yellow	Red
E	Chromel/Constantan	Purple	Red
T	Copper/Constantan	Blue	Red
R	Plat, 13% Rhodium/Plat	Black	Red
S	Plat, 10% Rhodium/Plat	Black	Red

Make the thermocouple wiring connections to terminals as shown in Figure 2.5.

Figure 2.5  
Thermocouple  
Connections

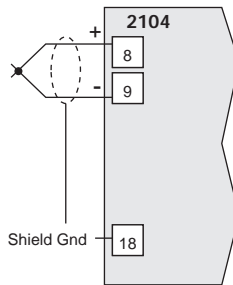

### 3-Wire RTD Inputs

When making the 3-wire RTD input connection, it is important to make the resistance of all three extension leadwires equal by using the same gauge and same length of wire for optimum leadwire compensation. Chromalox recommends 3-wire RTDs for greatest accuracy, and standard shielded copper wire for RTD extensions. Make 3-wire RTD connections to terminals 7, 8 and 9 as shown in Figure 2.6 on the following page.

Figure 2.6  
3-Wire RTD  
Connections

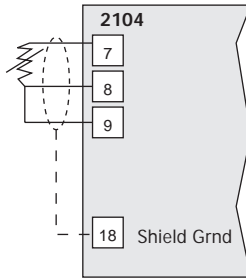

### 2-Wire RTD Inputs

If using a 2-wire RTD input, use heavier gauge leadwires to reduce leadwire resistance. Any leadwire resistance adds directly to sensor resistance, thus adding error to the process temperature measurement. It is also necessary to jumper terminals 8 and 9 on the instrument to complete a 2-wire hookup.

Figure 2.7  
2-Wire  
Connections

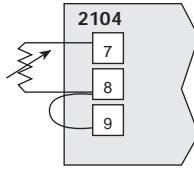

### Current/Voltage Inputs

Figure 2.8  
Current  
Input Wiring  
(Self-powered)

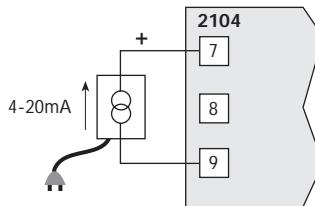
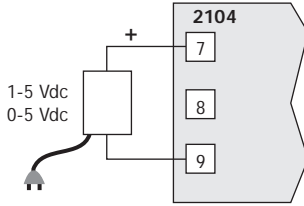
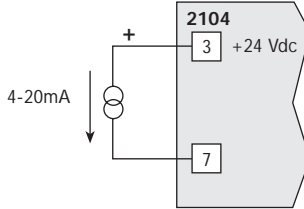

Figure 2.9  
Voltage  
Input Wiring  
(Self-powered)



The 2104 has a +24 Vdc power supply which can be used to power a 4-20mA transmitter.

Figure 2.10  
Current  
Input Wiring  
(Loop-powered  
by controller)



## Digital Input Connections

The digital input can be used in a number of ways:

- to control ramp/soak operations
- to switch between two setpoints, PID parameters, or Auto/Manual control
- to reset an alarm
- to disable the control output.

Setup for the digital input is shown on the  $\square E T$  setup page. An external switch, pushbutton or dry contact can be connected to this input. Use isolated switches only. Do not tie the Digital Input terminals to ground.

Figure 2.11  
Digital Input  
Connections  
External Switch

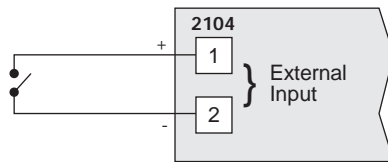
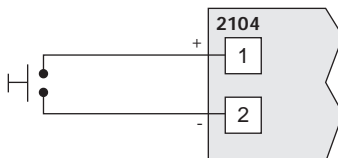

Figure 2.12  
Momentary  
Contact  
Pushbutton for  
Ramp/Soak



## Output Wiring

The 2104 is supplied with either:

- 1 Control Output for Single Output Control (#1)
- 2 Control Outputs for Heat/Cool Control (#1 and #2)

The output wiring varies depending on the control type and applications. The wiring instructions are presented separately for each of these two controller types/applications.



### Warning

Incorrect output wiring may cause system/process damage.

## Single Output Control Wiring

### Relay Output

Output Code “RO” on the 2104 (2104 - RO\*\*\*) gives you the option of SSR Drive or Relay control for output #1. When shipped from the factory, the relay output is active.

Figure 2.13  
Relay Output Connections

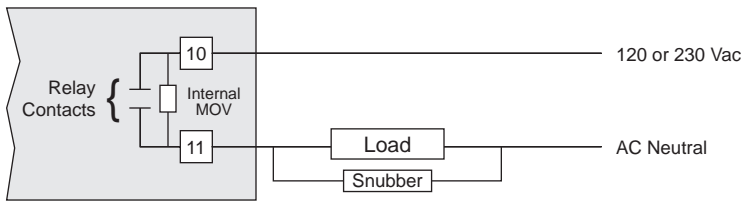

### SSR Drive Output

For SSR drive output applications, you must move an internal jumper on the Output #1 module to select SSR output. Remove the controller from its housing, and locate the output module as shown in Figure 2.14 on the following page. Reposition the jumper to select SSR Drive output.

Figure 2.14  
SSR Drive Output  
Jumper Position

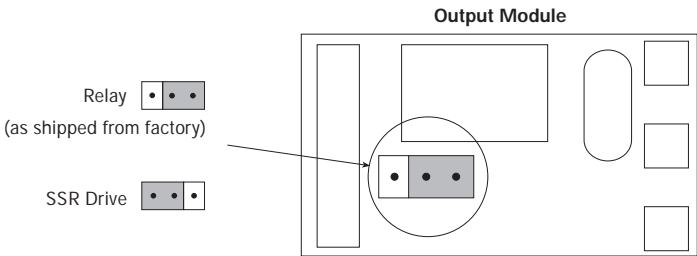
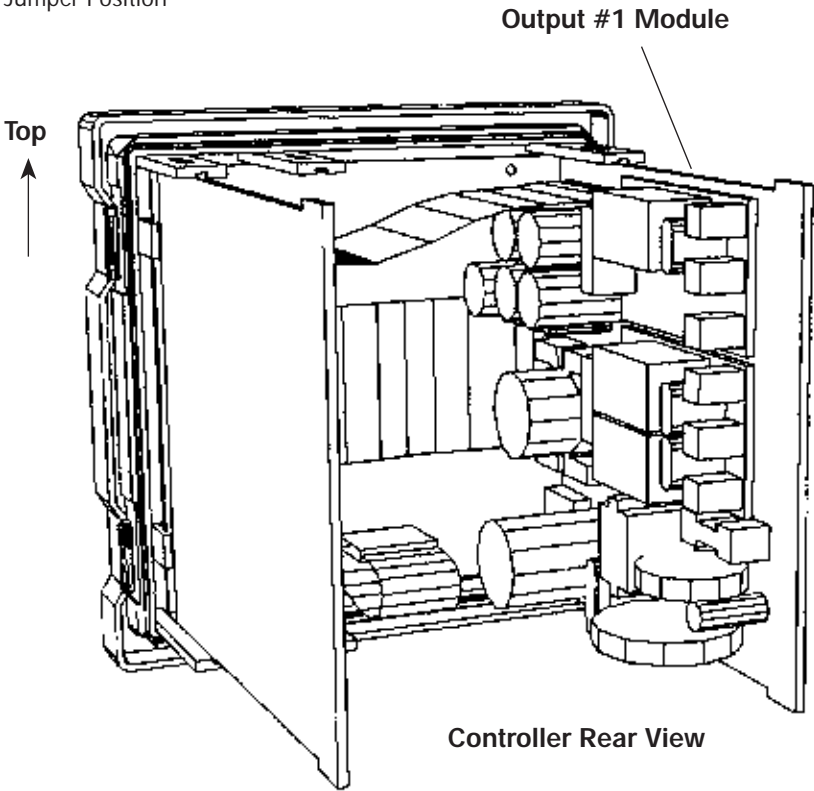

## Solid State Relay Drive Connections

The solid state relay drive output drives solid-state relays, such as the Chromalox 4115 or 4117 power modules, which accept 3 to 32 Vdc input ON signals and 0 Vdc OFF signals. See Figure 2.15 for solid state relay drive output connections.

Note: Negative lead connects to Terminal #2.

Figure 2.15  
Solid State Relay Drive Output Connections

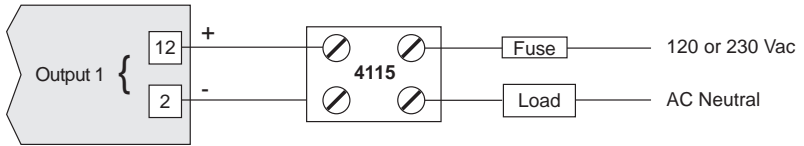

## Current/Voltage Output

Controllers with output codes "AO," "AA," "AR" and "AT" give you the option of 4-20mA or 1-5 Vdc output. When shipped from the factory, these control outputs are configured for 4-20mA output. For 1-5 Vdc output, you must access the internal output board and move the jumper(s) to the 1-5 Vdc position, as shown in Figure 2.16 on the following page.

Figure 2.16  
 Current/Voltage  
 Output Jumper Positions

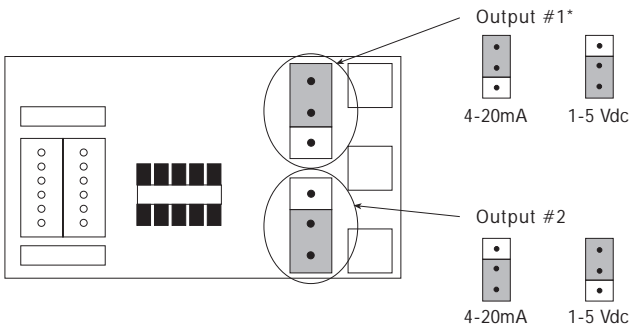
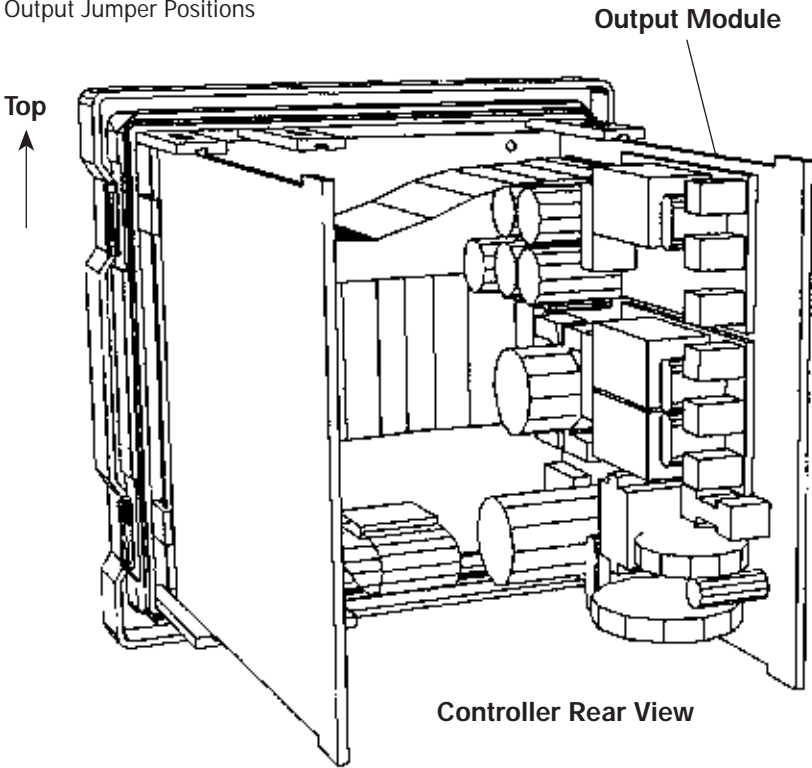

\*All controllers with Analog Output (output codes AR, AT) for output #1 use same 4-20mA/1-5 Vdc jumper positions as shown here.

Figure 2.17  
 Triac Output Connections

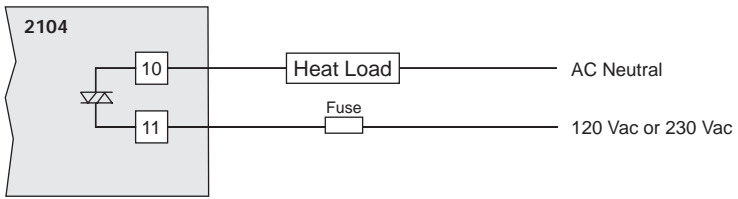

Figure 2.18  
 4-20mA Analog Output Connections

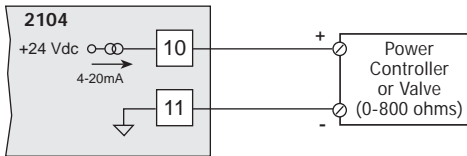
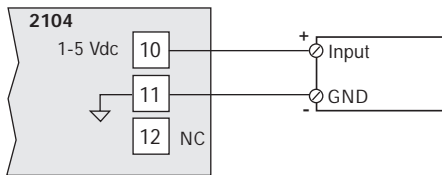

Figure 2.19  
 1-5 Vdc Output Connections



## Heat/Cool Control Output Wiring

Figure 2.20  
Dual Relay Output Wiring

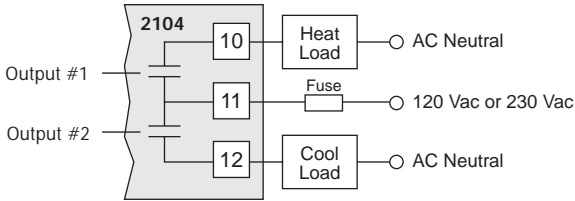

Figure 2.21  
Dual Triac Output Wiring

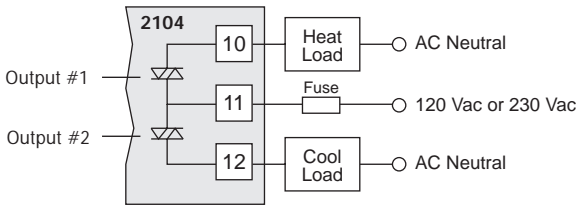

Figure 2.22  
Dual Analog Output Wiring

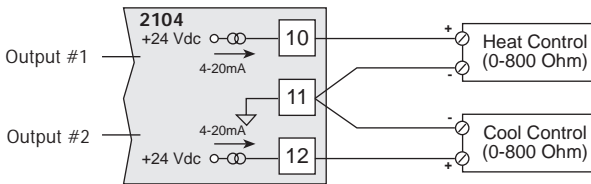
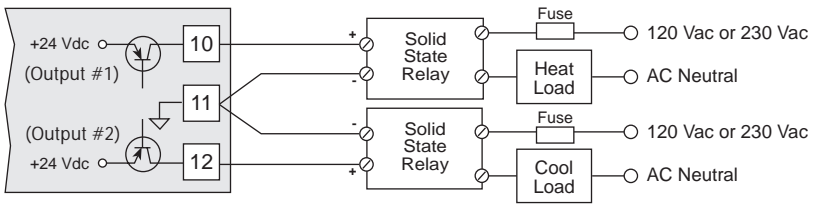
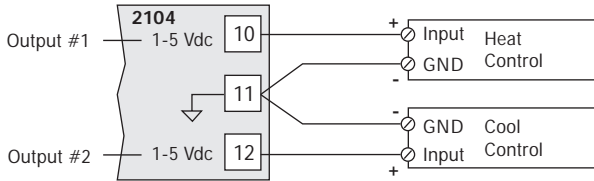

Figure 2.23  
Dual SSR Drive Output Wiring



## Heat/Cool Control Output Wiring (continued)

Figure 2.24  
Dual 1-5 Vdc Output Wiring\*



\*Note: See page 14 for Analog/Voltage jumper positions.

Figure 2.25  
Dual Output SSR/Relay Wiring

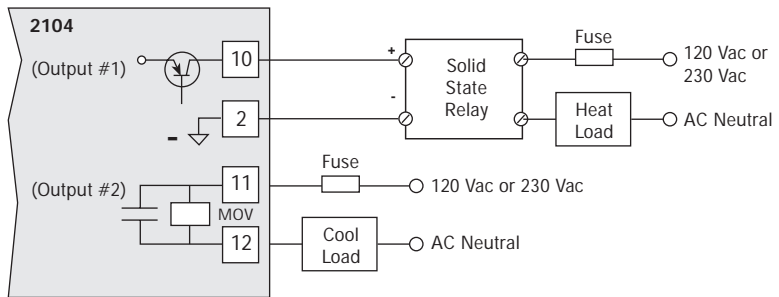
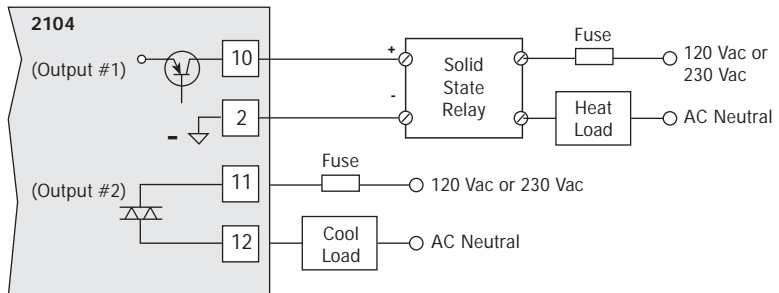

Figure 2.26  
Dual Output SSR/Triac Wiring



## Heat/Cool Control Output Wiring (continued)

Figure 2.27  
Dual Output Analog/Relay Wiring

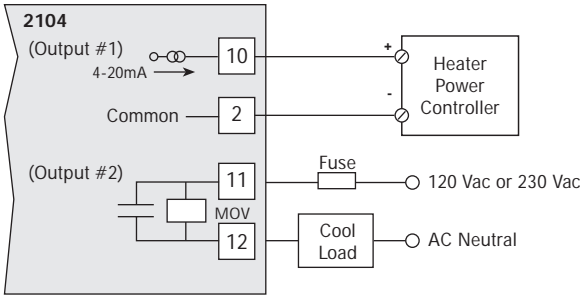
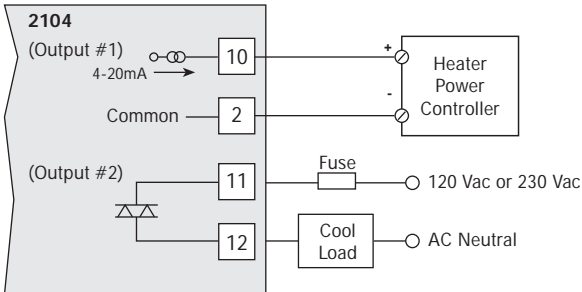

Figure 2.28  
Dual Output Analog/Triac Wiring



## Instrument Power Wiring

Make 120 Vac or 230 Vac instrument power connections to terminals 16-18 as shown in Figure 2.29.

Figure 2.29  
100-240 Vac  
Instrument  
Power  
Connections  
(2104-\*\*\*\*0)

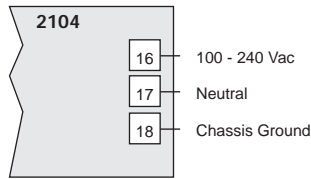
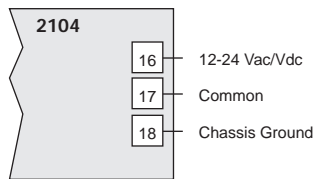

Figure 2.30  
12-24 Vac/Vdc  
Instrument  
Power  
Connections  
(2104-\*\*\*\*1)



## Alarm/Events Outputs #3 & #4

The two independent alarm (Output #3 or #4) relay outputs are connected as shown in Figure 2.31.

Figure 2.31  
Alarm/Event Outputs #3 and #4

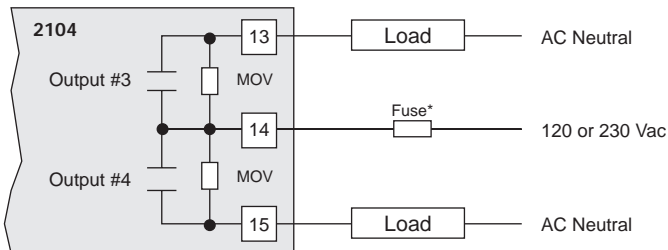

\* Fuse should be sized for the combined current of Output #3 and #4.

**Alarm/Event Output #5** The Form C Relay Output is connected as shown in Figure 2.32.

Figure 2.32  
Alarm/Event  
Output #5

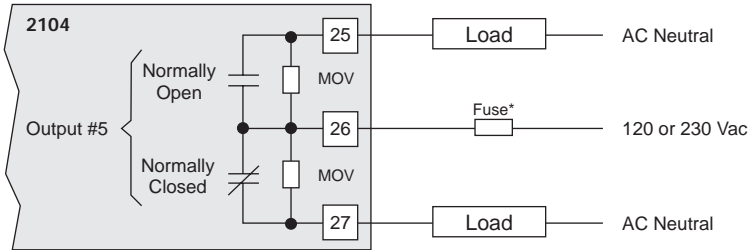

\* Fuse should be sized for the current of Output #5.

**Section  
Contents**

*Pushbuttons and Indications*

*Security Codes and Levels*

*Controller Operation*

**Pushbuttons  
and  
Indications**

Control programming is easily accomplished with the front panel pushbuttons. The displays provide a constant overview of the process. Figure 3.1, on the next page, summarizes the functions of the pushbuttons and displays.

**Normal Display Mode**

At powerup, and when the controller is not being programmed, the upper display shows the Process Value and the lower display shows the setpoint.

The setpoint can be changed in the Normal Display Mode using the ▲ and ▼ pushbuttons, if the Security Level allows setpoint changes (see page 26 for Security Levels).

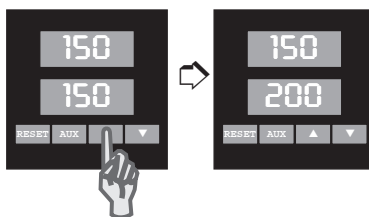

Use ▲ and ▼ to change setpoint in Normal Display Mode.

Figure 3.1  
Front Panel  
Identification

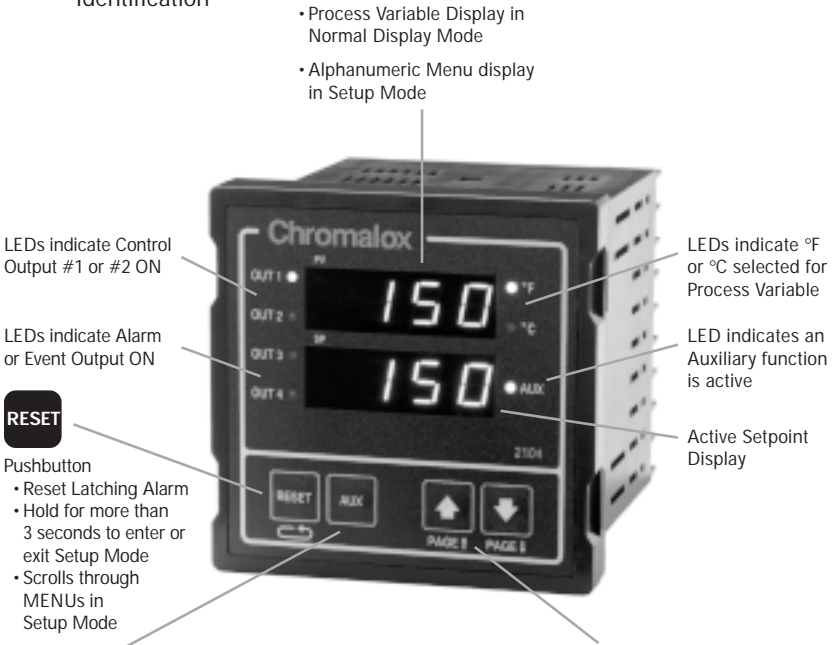

**AUX**

Programmable Pushbutton

- PID1/PID2 Toggle Switch
- Auxiliary Setpoint Enable
- Remote Setpoint Enable
- Output Disable
- Ramp/Soak Operations
- Auto/Manual Selector



- In Normal Display Mode, pushbuttons adjust Setpoint.
- In Setup Mode, pushbuttons increase/decrease MENU values.
- Ramp to Setpoint, press once to determine target setpoint.
- For Ramp/Soak Operation:



## PAGE/MENU Setup

All control parameters, selections and calibration procedures for the 2104 are accomplished through simple MENU selections. These MENU selections are organized into PAGES. On each PAGE you will find a specific set of related functions.

This organization allows you to go directly to the parameter to be adjusted, without stepping through a long series of unrelated entries. Figure 3.2 illustrates the 2104 PAGE/MENU setup structure. Only pages that apply to your unit will be displayed (i.e. if you do not have Digital Communications option, this page will not appear).

Figure 3.2  
PAGE/MENU Setup Structure

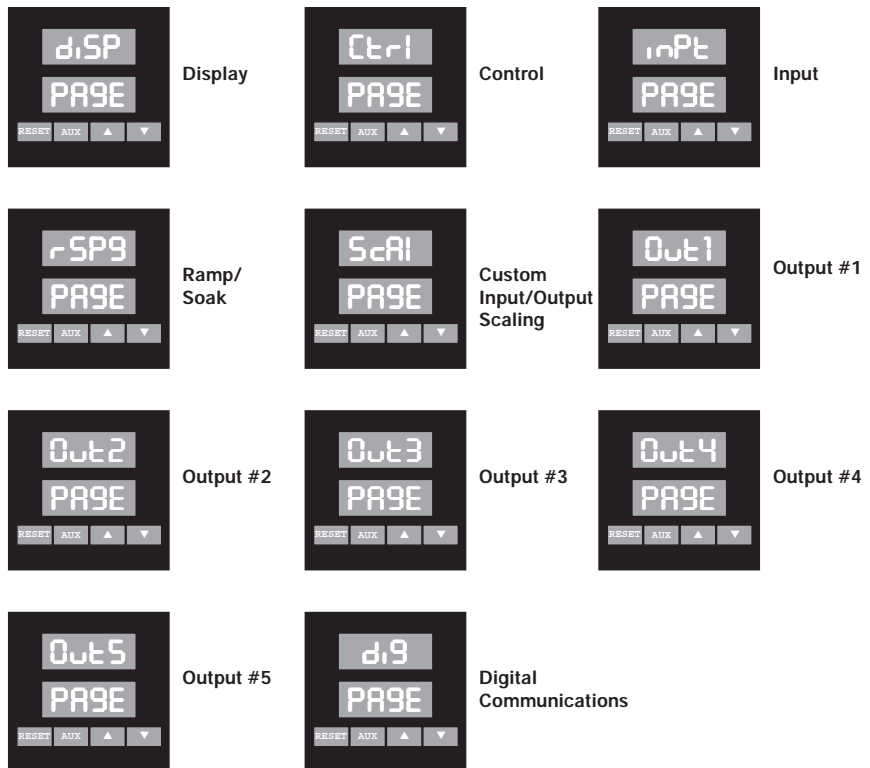

Accessing a MENU is accomplished by entering the Setup Mode, then selecting a PAGE and MENU.

### To enter Setup Mode:

Hold down the RESET pushbutton for longer than 3 seconds.

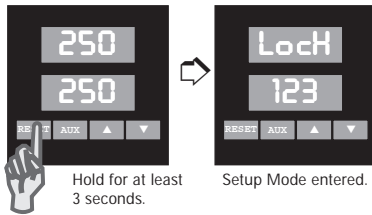

### To select a PAGE:

Press and hold the Reset pushbutton, while pressing the ▲ or ▼ Pushbutton. The upper display will increment (or decrement) through the PAGES, and PAGE will be displayed in the lower display.

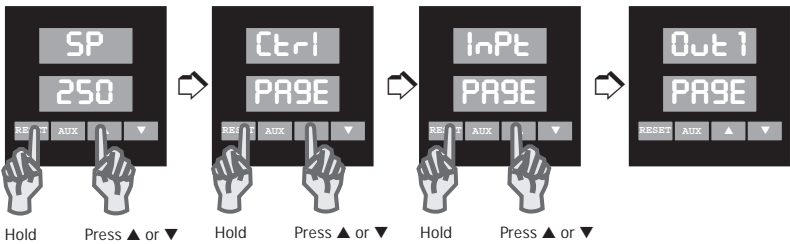

### To select a MENU:

After reaching the correct PAGE, press RESET to move through the MENUS. The alpha cue for the MENU will appear on the upper display, and the current value will appear in the lower display.

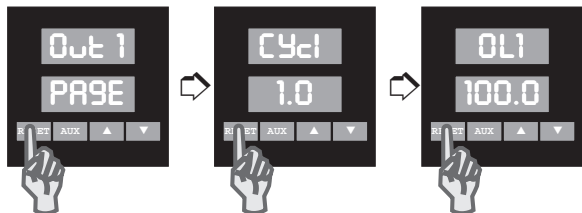

### To change a MENU value:

After the MENU is selected and displayed, use the ▲ and ▼ pushbuttons to change the value. For large adjustments (for example, 100 to 200), hold the pushbutton pressed and the display will change more quickly.

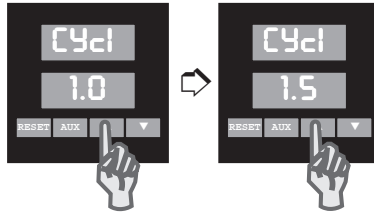

### To return to Operating Mode:

Press and hold RESET for more than 3 seconds. The controller will automatically return to operating mode after 10 minutes of no pushbutton activity.

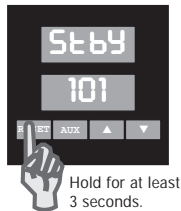

Figure 3.3  
Sample of  
PAGE/MENU  
Table

Control Page			
MENU	Description	Available Settings	Security
<b>Loch</b>	Security Lock	0 to 9999	A
<b>SP</b>	Setpoint	Instrument sensor span	B
<b>AuSP</b>	Auxiliary SP	Auxiliary setpoint is accessible only if AUX pushbutton or Event Input is setup for Auxiliary Setpoint. Instrument Sensor Span	C
<b>tune</b>	Self Tune	Self-Tune automatically adjusts PID parameters on powerup (P-uP) or on demand (BE9n).	
		OFF = Self-tuning disabled P-uP = Power-up tuning BE9n = Begin tuning	

## Security Levels

Every parameter or selection in the 2104 controller's setup PAGES has an identifying MENU. Each MENU is assigned one of four Security Levels, A-D. In each level you may view certain MENUs, and *adjust* certain MENUs. This allows you to set the Security level that is appropriate for your operating environment, prohibiting unauthorized access to or accidental changing of control parameters.

Figure 3.4  
Security Levels and PAGE/MENU Contents

Level	Code	Description
A	---	Display Page and Security Lock
B	123	Setpoint and Auxiliary Setpoint
C	458	Settings for: Control Input Ramp/Soak Digital Communications
D	736	Calibration Security Codes

## Entering the Security Code

The Security Code is entered on the Control PAGE  $\text{Ctrl}$ , at the MENU  $\text{Lock}$ . This code determines which MENUs may be viewed and adjusted.

The controller is set at Security Level A (view only, no adjustments) when you receive it from Chromalox.

## To access and enter the Security Code:

1. Press and hold RESET for more than 3 seconds to enter Setup Mode. Security Lock is the first menu that will appear.

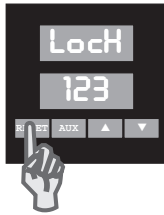

## Security Codes

Figure 3.5 lists the Security Codes for each of the four Security Levels, along with the levels that may be viewed and adjusted.

Figure 3.5  
Security Codes &  
View/Adjust  
Levels

<u>Security Level</u>	<u>Security Code</u>	<u>View Level</u>	<u>Adjust Level</u>
<b>A</b>	- - -	A	A
<b>B</b>	<b>123</b>	A, B	A, B
<b>C</b>	<b>458</b>	A, B, C	A, B, C
<b>D</b>	<b>736</b>	A, B, C, D	A, B, C, D

If a number other than one of the three codes listed above is entered at Loch on the Enter PAGE, adjustment of all parameters is locked out. An additional security number can be added using the menu for User Selectable Security Code (Enter PAGE, menu Code).

## Control Operation

The 2104 Controller is capable of single output and heat/cool PID control. The selection for single or heat/cool control is made in the Controller Type menu (Ctrl PAGE, Cont) with PID settings also in the Control Page. Additionally, the 2104 features ramp to setpoint and ramp/soak capabilities.



### Control Algorithms

PID is the standard control algorithm of the 2104. ON/OFF control action is selected by setting the proportional band (Ctrl PAGE, Pbl or Pb2) to zero. Two sets of PID and ON/OFF control parameters are located in the Control Page for increased flexibility. Additionally, a Fuzzy Logic algorithm can be used to help prevent overshoot at power-up or during upsets.

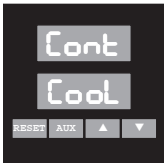

### Standard Single Output Control

In standard single output control (Ctrl PAGE, Cont = HEAT or Cool) the Sensor Input is used to measure the process variable and Output #1 is used to control the process. PID1 parameters (Ctrl PAGE, Pbl, R-1, rA1) are used to determine the response of the control loop.



### Heat/Cool Control

In heat/cool control (Ctrl PAGE, Cont = HECL) Outputs #1 and #2 are used to control the process. Output #1 acts as the Heat output and Output #2 acts as the Cool output. PID1 parameters (Ctrl PAGE, Pbl, R-1, rA1) are used to determine the response of the Heat output and PID2 parameters (Ctrl PAGE, Pb2, R-2, rA2) are used for the cool output.

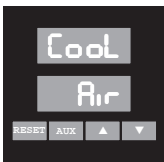

One way to automatically set the PID2 parameters is via the cooling medium parameters. These are setup at menu Cool on the Ctrl PAGE.

Cooling Medium parameters automatically establish the optimum PID2 cooling parameters, based on the cooling medium used/selected. If air, oil or water cooling medium is selected, and PID1 parameters change (during self-tune OR Manually), PID2 parameters will also be adjusted. If "Pid2" is selected (PAGE Ctrl, Cool = Pid2, no cooling medium specified), the PID2 parameters will change only if changed in Menus Pb2, R-2 and rA2.

## Control Operation (continued)



## Self-Tuning

The 2104 tuning algorithm establishes PID constants ( $Pb1$ ,  $Rr1$ ,  $rAt1$ ) that will bring the process to setpoint as quickly as possible with little overshoot. Tuning can be performed at powerup (Ctrl PAGE, tune = PrUp) or can be initiated immediately (Ctrl PAGE, tune = BEgn). When tuning, the 2104 will flash "tune" in the lower display.

If the process variable is not at least 50°F (28°C) away from setpoint, the 2104 will turn off the control output until the process temperature is 50°F from setpoint. If the 50°F temperature difference is not reached within 30 minutes, "Error" will be displayed, indicating that tuning was not successful (tuning error). Press RESET to clear "Error". After successfully tuning, tuning is turned OFF in the tuning menu (tune).

## Heat/Cool Self-Tuning

For heat/cool control applications, when the cooling medium is specified (PAGE Ctrl, Cool = Rr, H2O, Oil), both heat (PID1) and cool (PID2) parameters are computed during a heat tune (tuning is invoked while the process temperature is at least 50°F below setpoint). If no cooling medium is specified (PAGE Ctrl, Cool = PID2) the PID2 parameters ( $Pb2$ ,  $Rr2$ ,  $rAt2$ ) will not change during a self-tune.

A cool tune (tuning is invoked while the process temperature is at least 50°F above setpoint) will compute PID parameters for cooling only. One way to initiate a cool tune is to first heat tune, then lower the setpoint by 50°F (28°C) and initiate self-tuning for cooling (Ctrl PAGE, tune = BEgn). A cool tune will change PID2 settings if Heat/Cool control is selected for the control type (Ctrl PAGE, Cont HtCl).

## Control Operation (continued)



### Fuzzy Logic Overshoot Protection

Fuzzy Logic Overshoot Protection (CTRL PAGE, FL) works to minimize the overshoot that accompanies standard PID control. The 2104 actively learns the characteristics of the load and adjusts the PID control algorithm to reduce overshoot. Overshoot Protection, when combined with PID constants established by the 2104 tuning algorithm, produces a response that brings the process to setpoint with a minimum of overshoot. Fuzzy Logic overshoot protection is not possible with ON/OFF type control. It is recommended that Fuzzy Logic is always enabled.



### Ramp to Setpoint

(CTRL PAGE, rRt = 1 to 9999 degrees/hour or OFF)

The Ramp to Setpoint feature allows the control setpoint to be ramped to the final value at powerup or during operation when the setpoint is adjusted. At powerup, the setpoint is ramped from the current measured process temperature to the control setpoint. During operation, the setpoint is ramped from the current value to the new value. When enabled, Ramp to Setpoint will begin in any of the following situations:

- Powerup
- Change of setpoint from front panel
- Change of setpoint from digital communications
- Digital Input or Aux Key used to change between the local and auxiliary setpoints
- Digital Input or Aux Key used to change between the local and remote setpoints
- Remote Setpoint is active and the remote device changes the setpoint faster than the programmed ramp rate

## Control Operation (continued)



## Manual Operation

Manual operation allows the controller output command to be controlled from the front panel Keyboard. On initial powerup, the controller enters Automatic control mode (closed loop). When Manual Mode is entered, the output command appears in the lower display. The output command can be adjusted using the up and down arrow keys. The manual mode can be entered by using the Aux Key or the Digital Input (ENTER, **PAUSE**, **Ent1** or **Auto**). Manual Operation is not possible when ramp/soak is enabled. In the heat/cool control mode, only the currently active control output can be adjusted.

The transfer between Automatic and Manual operation is bumpless and balanceless. When switching from automatic to manual control, the controller assumes the last output command from automatic mode. When returning to automatic control, the output is forced to be the last manual mode output command.

If automatic reset is enabled (ENTER **PAUSE**,  $R_r = \text{non-zero value}$ ) the integral value slowly changes the output value until it reaches the correct automatic (PID) output value. If automatic reset is not enabled, the output is ramped from the last manual output command to the current automatic output command at a rate determined by the disintegration time menu (ENTER **PAUSE**, **Auto**).



## Section 4 Controller Setup PAGES

---

### Section Contents

This section contains detailed information for the following controller setup pages:

- diSP: Display
- Ctrl: Control
- INPt: Input
- ScAL: Custom Scaling
- Out1: Output #1
- Out2: Output #2

Setup PAGES specific to certain functions are located in the section of this manual that addresses that function specifically.

Section	Page	Topic	Setup PAGE
5	<b>41</b>	Ramp/Soak	rSPG
6	<b>47</b>	Alarms and Events	Out3, Out4, Out5
8	<b>67</b>	Remote Setpoint Input and Analog Output Option	Ctrl, INPt, ScAL
9	<b>71</b>	Digital Communications	diS

More  
Info.

Throughout the following Setup PAGES you will find these symbols **40**. This indicates a section of this User's Manual where more specific information on a parameter/application/feature can be found.



The Display Page is for status only.  
None of the settings can be changed.

### Display Page

<u>MENU</u>	<u>Description</u>	<u>Displays</u>	<u>Security</u>
<b>Proc</b>	Process Variable	Sensor Span	A
<b>ASP</b>	Active Setpoint	Sensor Span	
<b>Out1</b>	Output #1 Command	<b>0.0 to 100.0%</b>	
<b>Out2</b>	Output #2 Command	<b>0.0 to 100.0%</b>	
<b>rSP</b>	Remote Setpoint Input	Sensor Span	
<b>rS</b>	Ramp/Soak Status	<b>OFF</b> = Program not running <b>run</b> = Program running <b>Hold</b> = Program in hold <b>Stby</b> = Program in standby <b>95</b> = Guaranteed soak	
<b>int</b>	Ramp/Soak Interval Number	<b>0 - 16</b>	
<b>LEft</b>	Ramp/Soak Time Left in Interval	<b>0.0 to 999.9</b> hr/min/sec	
<b>LoOP</b>	Ramp/Soak Loops Remaining	<b>0 - 9999</b>	
<b>Al r</b>	Alarm Output Status	<b>None</b> = No alarms <b>A3</b> = Alarm Output #3 <b>A4</b> = Alarm Output #4 <b>A43</b> = Alarm Outputs #4 and #3 <b>A5</b> = Alarm Output #5 <b>A53</b> = Alarm Outputs #5 and #3 <b>A54</b> = Alarm Outputs #5 and #4 <b>A543</b> = Alarms 5, 4 and 3	
<b>Ent</b>	Event Output Status	<b>None</b> = All off <b>E3</b> = Event Output #3 <b>E4</b> = Event Output #4 <b>E43</b> = Event Outputs #4 and #3 <b>E5</b> = Event Output #5 <b>E53</b> = Event Outputs #5 and #3 <b>E54</b> = Event Outputs #5 and #4 <b>E543</b> = Events 5, 4 and 3	



**Control Page**

MENU	Description	Available Settings	Security
<b>Loch</b>	Security Lock <b>26</b>	0 to 9999	A
<b>SP</b>	Setpoint	Instrument sensor span	B
<b>AUX SP</b>	Auxiliary SP	Auxiliary setpoint is accessible only if AUX pushbutton or Event Input is set up for Auxiliary Setpoint. Instrument Sensor Span	
<b>tune</b>	Self-Tune <b>29</b>	Self-Tune automatically adjusts PID parameters on powerup (PrUP) or on demand (BEGn).  OFF = Self-tuning disabled PrUP = Power-up tuning BEGn = Begin tuning	C

**PID1 (Pb1 - db1) applies to Output #1 in heat/cool mode. For single output control, PID1 (Pb1-db1) can be switched with PID2 (Pb2 - db2) settings via AUX pushbutton or Digital Input.**

<b>Pb1</b>	Proportional Band 1	0°F to sensor range 0°F displays as ON/OFF to indicate ON/OFF control	C
<b>Rr1</b>	Automatic Reset 1	0.00 to 99.99 repeats/minute	
<b>rRt1</b>	Rate 1	0 to 500 seconds	
<b>db1</b>	Dead Band 1	db1 is not used unless Pb1 is set to zero. 1 to 100°F 0.01 to 6.25% span for analog inputs	

**PID2 (Pb2 - db2) applies to Output #2 in heat/cool mode. For single output control, can be used for Output #1, if switched via AUX pushbutton or Digital Input.**

<b>Pb2</b>	Proportional Band 2	0°F to sensor range 0°F displays as ON/OFF to indicate ON/OFF control	
<b>Rr2</b>	Automatic Reset 2	0.00 to 99.99 repeats/minute	
<b>rRt2</b>	Rate 2	0 to 500 seconds	
<b>db2</b>	Dead Band 2	db2 is not used unless Pb2 is set to zero. 1 to 100°F 0.01 to 6.25% span for analog inputs	



### Control Page (continued)

MENU	Description		Available Settings	Security
<b>OFFst</b>	Manual Reset		-99.9 to 99.9	C
<b>FL</b>	Fuzzy Logic	<b>29</b>	OFF = Disabled On = Enabled	
<b>OpenS</b>	Open Sensor Output Command		In the event of an open sensor, control output will automatically adjust to % output preset. For Heat Only or Cool Only control, adjustable 0.0 to 100.0%. For Heat/Cool Control, adjustable: -100.0 to 100.0%: -100.0 to -0.1 for cooling 0.1 to 100.0 for heating	
<b>LoopP</b>	Control Loop Protection Timer	<b>55</b>	OFF, 0.1 to 999.9 minutes	
<b>Auto</b>	Auto/Manual Disintegration Timer		0 to 100 seconds	
<b>r-rAt</b>	Ramp Rate		OFF 1 to 9999 degrees/hour	
<b>Cont</b>	Controller Type	<b>28</b>	Controller type can be used as heat/cool (HECL) only if controller is equipped with Output #1 (Heat) and Output #2 (Cool). HEAt = Reverse Acting Single Output Controller COOL = Direct Acting Single Output Controller HECL = Heat/Cool Controller	
<b>COOL</b>	Cooling Medium	<b>28</b>	PId2 = Uses PID2 settings for cooling Air = Air Cooling Oil = Oil Cooling H2O = Water Cooling	
<b>r-SP</b>	Remote Setpoint Enable		OFF On	
<b>Ent1</b>	Event/Digital Input Function	<b>59</b>	nonE = Disabled PId2 = PID2 enable RUSP = Auxiliary SP enable r-SP = Remote SP enable Outd = Output disable rS = Ramp/Soak Auto = Auto/Manual Al r = Alarm Reset	



**Control Page (continued)**

<u>MENU</u>	<u>Description</u>		<u>Available Settings</u>	<u>Security</u>
<b>Au</b>	Auxiliary Pushbutton Function	<b>60</b>	nonE = Disabled Pid2 = PID2 enable AuSP = Auxiliary SP enable rSP = Remote SP enable Outd = Output disable Auto = Auto/Manual	C
<b>Out</b>	Analog Output Assignment	<b>70</b>	nonE = Disabled Proc = Process Variable ASP = Active Setpoint Out1 = Control Output 1 Out2 = Control Output 2	
<b>rSEn</b>	Ramp/Soak	<b>41</b>	Ramp/Soak "On" enables the Ramp/Soak Setup Page (rSP9) OFF On	
<b>Code</b>	User Selected Security Code	<b>26</b>	Allows you to establish your own user-defined security code. 0-122 = Level A 123-457 = Level B 458-735 = Level C 736-999 = Level D	D



## Input Page

MENU	Description	Available Settings	Security
<b>SEnS</b>	Sensor Type <b>4</b>	Sensor Type selected here must agree with dip switch settings. J = J Thermocouple K = K Thermocouple T = T Thermocouple E = E Thermocouple R = R Thermocouple S = S Thermocouple B = B Thermocouple rtd = 100Ω Pt RTD ( $\alpha = .00385$ ) 4-20 = 4 to 20mA 0-5 = 0 to 5 Vdc 1-5 = 1 to 5 Vdc rtdt = 100 Ω Pt RTD (0.1° resolution)	C
<b>unIt</b>	Display Units	none = no units °F = Degrees Fahrenheit °C = Degrees Celsius	
<b>COFF</b>	Display/Calibration Offset <b>82</b>	Display/Calibration Offset offsets temperature process reading. -100°F to 100°F	
<b>Setpoint Limits prevent setpoints from being adjusted above or below these pre-established limits.</b>			
<b>SPLL</b>	Setpoint Low Limit	Instrument Sensor Span	
<b>SPUL</b>	Setpoint Upper Limit	Instrument Sensor Span	
<b>CALS</b>	Sensor Calibration	inLo inHi done	D
<b>CALr</b>	Remote Setpoint Calibration	inLo inHi done	
<b>AO0</b>	Analog Output Zero Calibration	0 to 4095	
<b>AO5</b>	Analog Output Span Calibration	0 to 4095	
<b>rECc</b>	Factory Calibration Recovery	rdY = Ready --- = Wait done = Finished	
<b>Digital Filtering menu (FLT) can be used to stabilize a fluctuating 0.1° resolution process variable display. To stabilize the display, increase the menu value (adjustable from 1 to 60 seconds).</b>			
<b>FLt</b>	Digital Filter	0 to 60 seconds	
<b>hPrC</b>	High (max.) Process Input	Instrument Sensor Span	
<b>LPrc</b>	Low (min.) Process Input	Instrument Sensor Span	
<b>hAR</b>	High (max.) Ambient Temp.	Instrument Sensor Span	
<b>LoAR</b>	Low (min.) Ambient Temp.	Instrument Sensor Span	



This PAGE appears only when Analog Input is selected, Remote SP is enabled, or Analog Output is enabled on Ctrl PAGE.

### Custom Scaling Page

MENU	Description		Available Settings	Security
<b>DP</b>	Analog Input Decimal Pts.	<b>9</b>	0 = none 1 = 123.4 2 = 12.34 3 = 1.234	C
<b>ALL</b>	Analog Input Low	<b>9</b>	-500 to 5000	
<b>AH</b>	Analog Input High	<b>9</b>	-500 to 5000	
<b>OLL</b>	Analog Output Low	<b>70</b>	-500 to 5000	
<b>OH</b>	Analog Output High	<b>70</b>	-500 to 5000	
<b>rSPL</b>	Remote SP Input Low	<b>67</b>	-500 to 5000	
<b>rSPH</b>	Remote SP Input High	<b>67</b>	-500 to 5000	



### Output #1 Page

MENU	Description		Available Settings	Security
<b>CYc1</b>	Output #1 Cycle Time		0.0 to 60.0 seconds 0.0 = Voltage/Current algorithm	C
<b>OLI</b>	Output #1 Limit		0.0 to 100.0%	
<b>HoFF</b>	Heat Offset		0°F to PB1 setting	



This PAGE is visible only if setup for heat/cool control on Ctrl PAGE.

### Output #2 Page

MENU	Description		Available Settings	Security
<b>CYc2</b>	Output #2 Cycle Time		0.0 to 60.0 seconds 0.0 = Voltage/Current algorithm	C
<b>OLI2</b>	Output #2 Limit		0.0 to 100.0%	
<b>CoFF</b>	Heat Offset		0°F to Pb2 setting	



# Section 5

## Ramp/Soak Operation

---

The 2104 controller features a Ramp/Soak Program. The program consists of 16 intervals plus a standby interval. The time span and setpoint for each interval are individually adjustable. These intervals make up a Ramp/Soak Profile. An example of a typical 8-interval Ramp/Soak program is shown below.

Figure 5.1  
Ramp/Soak Profile

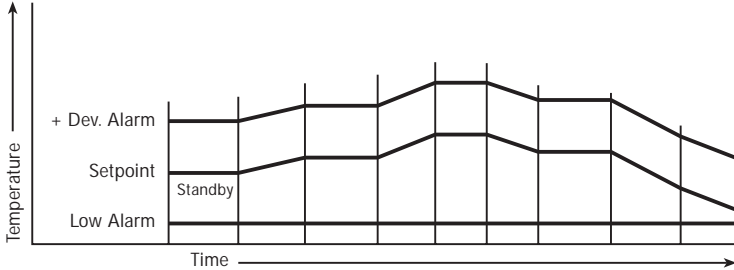

### Event Outputs

Event Outputs may be configured to turn ON or OFF during each of the intervals. Event outputs are merely timed outputs that are either ON or OFF during an entire interval.

Examples of event outputs might be annunciation of a soak interval, an indicator light or addition of a product to the process. Outputs #3, #4 and #5 (if your controller was purchased with these options) may be setup as event outputs. For Outputs #3, #4 or #5 to be used as Events, the output must be set up as an Event on its setup page (i.e.  $\square\text{J}\text{E}\text{E}$ ). For example, for Output #3 to turn on during interval 2, set menu  $\text{2E}$  (interval 2 event) to  $\text{E3}$  (Output #3 on). See page 43 for details.

Figure 5.2  
Event Outputs in Ramp/Soak Profile

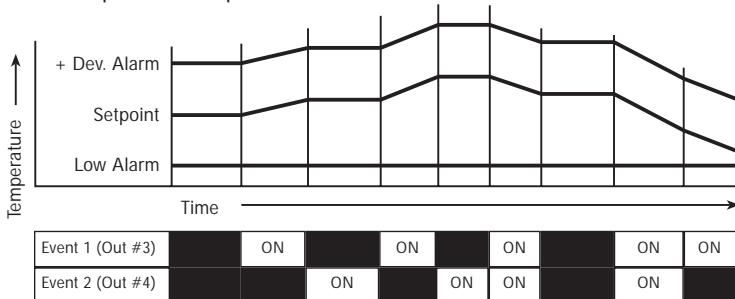

## Looping Intervals

Looping means that intervals within a Program may be repeated 1 to 9999 times. If a loop is inserted in the program shown in Figure 5.1, so that intervals 4, 5 and 6 will be repeated 2 times in addition to the single Program run of these intervals, the final profile would look Figure 5.3.

Figure 5.3  
Looping Intervals

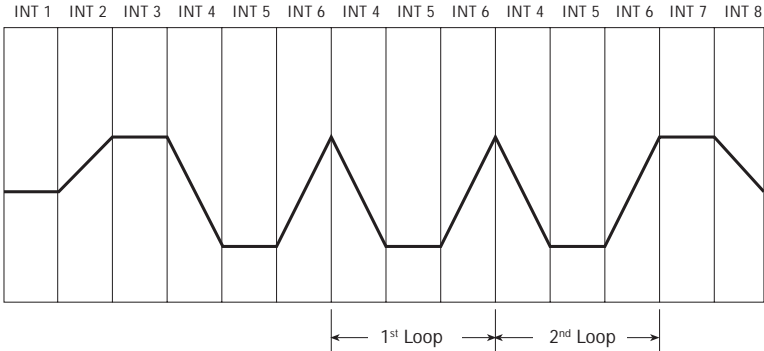

## Guaranteed Soak

This Ramp/Soak feature of the 2104, when enabled, assures that the “soaking” time in a “soak” interval does not begin until the process reaches setpoint or is within the guaranteed soak differential band. A soak interval has the same setpoint at the beginning and end of the interval.

Figure 5.4  
Guaranteed Soak

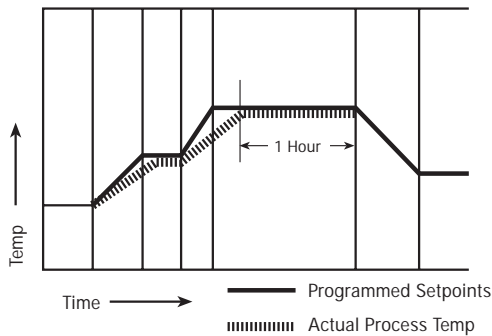

Guaranteed Soak is enabled on the `rSP3 PAGE` by setting the differential band to a value greater than 0. It is adjustable from 1°F to the sensor span.



This setup PAGE appears only if Ramp/Soak control is turned on. The Ramp/Soak Enable parameter is the next to the last menu on **Ctrl PAGE, Menu Cont.**

### Ramp/Soak Page

MENU	Description	Available Settings	Security
<b>unit</b>	Time Units	SEC = seconds (1 to 9999) min = minutes (0.1 to 999.9) hr = hours (0.01 to 99.99)	C
<b>Stby</b>	Standby Setpoint	Instrument Sensor Span	
<b>int1</b>	Interval 1 Time	see Time Units Menu (above)	
<b>SP1</b>	Setpoint 1 • Intervals 2-15 • Time and Setpoint	Instrument Sensor Span	
<b>int16</b>	Interval 16 Time	see Time Units Menu (above)	
<b>SP16</b>	Setpoint 16	Instrument Sensor Span	
<b>Cont</b>	Continuous Program	OFF On	
<b>From</b>	Loop from the end of interval	1 to 16	
<b>to</b>	To the beginning of interval	1 to 16	
<b>no</b>	Number of times	0 to 9999	
<b>StEt</b>	Standby Events	OFF = All off E3 = Event Output 3 On E4 = Event Output 4 On E43 = Event Outputs 4 & 3 On E5 = Event Output 5 On E53 = Event Outputs 5 & 3 On E54 = Event Outputs 5 & 4 On E543 = Event Outputs 5, 4, 3 On	
<b>int1E</b>	Interval 1 Events	OFF = All off E3 = Event Output 3 On E4 = Event Output 4 On E43 = Event Outputs 4 & 3 On E5 = Event Output 5 On E53 = Event Outputs 5 & 3 On E54 = Event Outputs 5 & 4 On E543 = Event Outputs 5, 4, 3 On	
<b>int16E</b>	Interval 16 Event	same as above	
<b>GSdb</b>	Guaranteed Soak differential	OFF, 1°F to sensor range	

## Control Operation

In order to use the Ramp/Soak program, it must be enabled on the  $\square$  Page,  $\square$  =  $\square$ . Control of ramp/soak operation (Start, Stop and Hold) can be accomplished via the front panel. In the Setup mode, first return to the Normal Display Mode by holding the reset button for 3 seconds. Pressing the up arrow key **Starts** the program, pressing the down arrow key **Holds** the program, and pressing both together **Stops** the program.

### To Start Ramp/Soak Program:

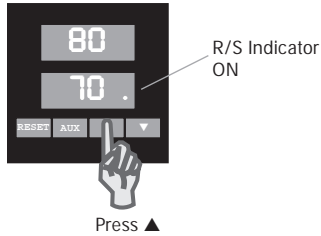

▲ **Starts** the Ramp/Soak program or if the program is on **Hold**, continues the program

### To Hold Ramp/Soak Program:

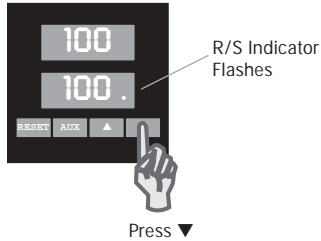

▼ (**Hold**) Stops the program in progress and "holds" the program until the ▲ (**Start**) button is pressed.

### To Stop Ramp/Soak Program:

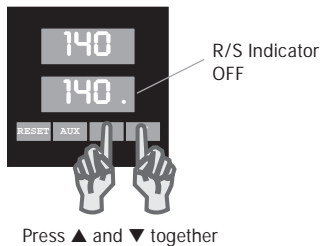

▼ and ▲ together (Stop Pushbutton) return the Ramp/Soak program to the Standby setpoint.

**Control  
Operation**  
(continued)

**Ramp/Soak (continued)**

Alternately, the Digital Input or *Chromasoft™* can be used to control program operation. The ramp/soak indicator LED (right-most decimal point in the lower display) is ON when a program is running, OFF in standby, and flashes in hold mode.



**Note:** If the Aux key function is set to none (Ctrl PAGE, Au = none), the current ramp/soak status will be displayed when the Aux key is pressed.

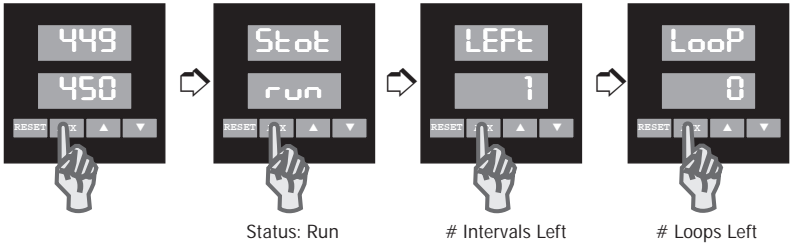



The 2104 controller can provide up to three alarm outputs using Output #3, #4 and #5. These optional outputs are indicated by the following controller model numbers:

<u>Optional Outputs</u>	<u>Model Number</u>
Outputs #3 and #4	2104 - **1**
Output #5	2104 - ***1* ***2*
	2104 - ***4* ***5*

Each alarm is individually setup with a high and low setpoint on its own Page:

- Output 3 PAGE
- Output 4 PAGE
- Output 5 PAGE

Outputs #3, #4 and #5 can be individually setup as Alarms or Events, and can be individually disabled.

To function as an alarm, the output type must be specified as an alarm output, ALR, in the first menu, output type (E4P3, E4P4, E4P5). If the function is an Event, the output type must be specified as ENT. The Events then are enabled in the Ramp/Soak (rSP3) page, menus S6E6 (Standby Event) through I6E.

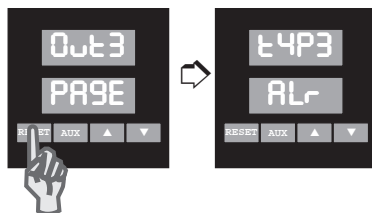

**Alarm Types** Each of the alarms can be set up for the following alarm types:

- Hi** High Alarm—Absolute Temperature Alarm
- Lo** Low Alarm—Absolute Temperature Alarm
- HiLo** High/Low Alarm—Absolute Temperature Alarm
- PdE** +Deviation Alarm—Setpoint Tracking Alarm
- dE** -Deviation Alarm—Setpoint Tracking Alarm
- dE** ±Deviation Alarm—Setpoint Tracking Alarm
- LoopP** Control Loop Protection Alarm—System Alarm  
(see page 53 for detailed information)

The Absolute Temperature Alarms are set to a specific value; i.e. if the High Alarm is set for 100°F, the alarm will turn on at 100°F. The Deviation Alarms, or Setpoint Tracking Alarms, track the process setpoint. If the Alarm = 5°F and the setpoint is 70°F, the Alarm will energize at 75°F.

**Alarm Inhibit**

When enabled, the Alarm Inhibit feature prevents false alarms during initial powerup. For example, the low alarm will not be set until after the process temperature has initially reached setpoint. Alarm Inhibit is adjustable for each alarm output.



**Alarm Wiring**

Wiring instructions for Outputs #3, #4 and #5 are given on pages 19-20.

**Alarm  
Relay  
Action**

Output Relays #3, #4 and #5 can be set to be normally energized or de-energized, latching or non-latching. A normally de-energized relay is in its non-energized state when not in alarm. For example, Outputs #3 and #4 are normally-open contacts. When setup as normally de-energized, the relays will be open when not in alarm, and closed when in alarm.

A non-latching relay will not stay in alarm if the alarm condition goes away. A latching relay will not go out of alarm until the alarm condition no longer exists and **RESET** is pressed.

**Alarm  
Operation**

Latching alarms can be reset by pressing the RESET pushbutton on the controller front panel. The alarm cannot be reset until the process is out of the alarm condition. The Digital Input can be setup to function as a remote alarm reset button (see pages 59-63).

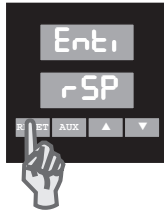



This setup PAGE appears only if the controller is equipped with Outputs #3 and #4.

### Output #3 Page

MENU	Description		Available Settings	Security
<b>Out 3</b>	Output #3 Type	<b>47</b>	OFF = Disabled Al r = Alarm Output Ent = Event Output (Setup Event Output parameters on Ramp/Soak Page)	C
<b>Al r 3</b>	Alarm #3 Type	<b>48</b>	none = Disabled (off) Hi = High Alarm Lo = Low Alarm HiLo = High-Low Alarm PdE = Plus Deviation Alarm -dE = Minus Deviation Alarm dE = Plus/Minus Deviation Alarm Loop = Control Loop Protection Alarm	
<b>Rel 3</b>	Alarm #3 Relay Action	<b>49</b>	ndE = Normally de-energized non-latching nE = Normally energized non-latching ndEL = Normally de-energized latching nEL = Normally energized latching	
<b>Low Setpoint is used for low and -deviation setpoints</b>				
<b>ALo 3</b>	Alarm #3 Low Setpoint		Instrument Sensor Span	
<b>High Setpoint is used for high and +deviation setpoints</b>				
<b>AHi 3</b>	Alarm #3 High Setpoint		Instrument Sensor Span	
<b>db 3</b>	Output #3 Dead Band (Alarm Hysteresis)		0 to 100°F	
<b>inh 3</b>	Alarm #3 Inhibit	<b>48</b>	OFF On	



This setup PAGE appears only if the controller is equipped with Outputs #3 and #4.

### Output #4 Page

MENU	Description		Available Settings	Security
<b>Output #4</b>	Output #4 Type	<b>47</b>	OFF = Disabled AO = Alarm Output EO = Event Output (Setup Event Output parameters on Ramp/Soak Page)	C
<b>Alarm #4</b>	Alarm #4 Type	<b>48</b>	OFF = Disabled (off) Hi = High Alarm Lo = Low Alarm HiLo = High-Low Alarm PdE = Plus Deviation Alarm -dE = Minus Deviation Alarm dE = Plus/Minus Deviation Alarm Loop = Control Loop Protection Alarm	
<b>Alarm #4</b>	Alarm #4 Relay Action	<b>49</b>	ndE = Normally de-energized non-latching nE = Normally energized non-latching ndEL = Normally de-energized latching nEL = Normally energized latching	
<b>Low Setpoint is used for low and -deviation setpoints</b>				
<b>ALo4</b>	Alarm #4 Low Setpoint		Instrument Sensor Span	
<b>High Setpoint is used for high and +deviation setpoints</b>				
<b>AHi4</b>	Alarm #4 High Setpoint		Instrument Sensor Span	
<b>db4</b>	Output #4 Dead Band (Alarm Hysteresis)		0 to 100°F	
<b>INH4</b>	Alarm #4 Inhibit	<b>48</b>	OFF ON	



This setup PAGE appears only if the controller is equipped with Output #5.

### Output #5 Page

MENU	Description	Available Settings	Security
<b>47PS</b>	Output #5 Type <b>47</b>	OFF = Disabled RI r = Alarm Output ENT = Event Output (Setup Event Output parameters on Ramp/Soak Page)	C
<b>RI rS</b>	Alarm #5 Type <b>48</b>	nonE = Disabled (off) Hi = High Alarm Lo = Low Alarm HiLo = High-Low Alarm PdE = Plus Deviation Alarm -dE = Minus Deviation Alarm dE = Plus/Minus Deviation Alarm Loop = Control Loop Protection Alarm	
<b>rLYS</b>	Alarm #5 Relay Action <b>49</b>	ndE = Normally de-energized non-latching nE = Normally energized non-latching ndEL = Normally de-energized latching nEL = Normally energized latching	
<b>Low Setpoint is used for low and -deviation setpoints</b>			
<b>ALoS</b>	Alarm #5 Low Setpoint	Instrument Sensor Span	
<b>High Setpoint is used for high and +deviation setpoints</b>			
<b>AHIS</b>	Alarm #5 High Setpoint	Instrument Sensor Span	
<b>dB5</b>	Output #5 Dead Band (Alarm Hysteresis)	0 to 100°F	
<b>INH5</b>	Alarm #5 Inhibit <b>48</b>	OFF On	

## Control Loop Protection Alarm (CLP)

Control Loop Protection (CLP) monitors the controller's process variable input and load output to detect and respond to conditions indicating a failure in the control loop (Sensor, Controller Output, Load or Process flow). CLP is selected by setting the Loop Timer on the CLP PAGE menu to a value from 0.1 to 999.0 minutes (0.0 disables CLP).

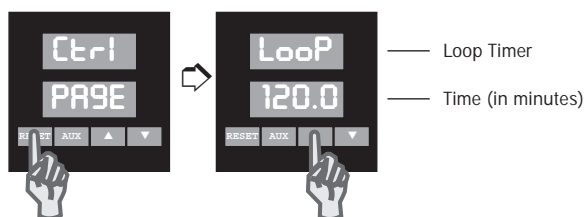

The timer setting should be chosen according to the response time of the system. The minimum time setting should be 0.25% of span divided by the normal load response rate to full ON or full OFF condition (whichever is slower).

$$\text{Minimum Timer Setting} = \frac{\text{Span} \times .0025}{\text{Slowest Response Rate (Heat or Cool)}}$$

Response Rate = Process Response (in degrees/minute) when  
100% ON or 100% OFF

**Example:** For a controller with type J T/C (span -100°F to 1400°F), 0.25% of span is 3.75°F. If the heating response is 2°F/min., and the cooling response is 1°F/min., the minimum Loop Timer setting would be 3.8 minutes. To prevent false alarms, it is recommended that you start by doubling the setting to 7.6 minutes.

The CLP Alarm sequence begins when the control output reaches 0.0% or 100.0% (process variable outside of the proportional band). The controller then measures the time for the process variable to respond (increase or decrease the process variable) and compares the measured time to the Loop Timer value.

### Control Loop Protection Alarm (continued)

If the control loop does not respond with a change in the process variable of 0.25% of span (3.75°F for a J thermocouple) within the programmed loop time, a Loop Error will result and the control output will turn off. The error will be indicated by the lower display flashing **Loop** and Loop Alarm Output (Output #3, #4, or #5 as selected on the menu) will be activated. The Loop Alarm is cleared by pressing **RESET**.

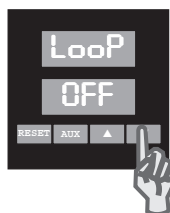

Press RESET  
to clear Loop Alarm







### Warning

The CLP is not a substitute for safety shutdown devices such as flow switches or overtemperature monitors. The CLP Alarm responds to specific conditions that may provide early warning of system loop failures or aid in troubleshooting failures.

## CLP Loop Alarm Conditions





The following table details conditions that activate a loop alarm, and gives the controller response to the condition.

Figure 6.1 CLP Loop Alarm Conditions

<b><u>Probable Cause</u></b>	<b><u>Control Output Response</u></b>	<b><u>Display</u></b>
Loss of process flow	Turns control output off	 Flashing
<p>In a control application where the process is being heated at one point and measured at a point downstream, CLP Alarm could be used to detect a flow failure. If the process flow is interrupted and heat is no longer transferred to the sensor, the controller output will increase to 100%, the Loop alarm will start timing the load response and when the preset Loop Timer value is reached, the Loop Alarm will be activated and the control output will be turned off. The failure will be indicated by the lower display flashing LoopP. Loop Alarm Output (Output #3, #4 or #5) will be activated if selected.</p>		
<b><u>Probable Cause</u></b>	<b><u>Control Output Response</u></b>	<b><u>Display</u></b>
Load Power is interrupted (blown fuse or tripped circuit breaker)	Turns control output off	 Flashing
<p>If load power is interrupted by the circuit protection devices (user supplied fuse or circuit breaker), the Loop Alarm will be activated when the process variable goes outside of the proportional band for a time greater than the preset Loop Timer value. The control output will be turned off and the failure will be indicated by the lower display flashing LoopP. Loop Alarm Output (Output #3, #4, or #5) will be activated If selected.</p>		
<b><u>Probable Cause</u></b>	<b><u>Control Output Response</u></b>	<b><u>Display</u></b>
Load fails (open circuit)	Turns control output off	 Flashing
<p>If the load fails open, the Loop Alarm will be activated when the process variable goes outside of the proportional band for a time greater than the preset Loop Timer value. The control output will be turned off and the failure will be indicated by the lower display flashing LoopP. Loop Alarm Output (Output #3, #4, or #5) will be activated if selected.</p>		
<b><u>Probable Cause</u></b>	<b><u>Control Output Response</u></b>	<b><u>Display</u></b>
Load fails (short circuit)	Turns control output Off	 Flashing
<p>If the load fails shorted, power to the load will be interrupted by the circuit protection devices (user supplied fuse or circuit breaker). The Loop Alarm will be activated when the process variable goes outside of the proportional band for a time greater than the preset Loop Timer value. The control output will be turned off and the failure will be indicated by the lower display flashing LoopP. Loop Alarm Output (Output #3, #4, or #5) will be activated if selected.</p>		



(continue on the next page)

Figure 6.1 CLP Loop Alarm Conditions (continued)

<u>Probable Cause</u>	<u>Control Output Response</u>	<u>Display</u>
Controller or remote power control output fails (open circuit)	Turns control output off	 Flashing
<p>If the controller output or the remote power control device (SCR or contactor) fails open, the Loop Alarm will be activated when the process variable goes outside of the proportional band for a time greater than the preset Loop Timer value. The failure will be indicated by the lower display flashing LoOP. Loop Alarm Output (Output #3, #4, or #5) will be activated if selected.</p>		
<u>Probable Cause</u>	<u>Control Output Response</u>	<u>Display</u>
Controller or remote power control output fails (short circuit)	None (load must be interconnected with alarm)	 Flashing
<p>If the controller output or the remote power control device (SCR or contactor) fails shorted, the Loop Alarm will be activated when the process variable goes outside of the proportional band for a time greater than the preset Loop Timer value. The failure will be indicated by the lower display flashing LoOP. Loop Alarm Output (Output #3, #4, or #5) will be activated. To protect the loop under this condition, the Loop Alarm Output (Output #3, #4 of #5) should be interconnected to remove power from the load.</p>		
<u>Probable Cause</u>	<u>Control Output Response</u>	<u>Display</u>
Sensor wiring reversed (thermocouple only)	Turns control output off	 Flashing
<p>If the sensor wiring is reversed, the Loop Alarm will be activated when the process variable goes outside of the proportional band for a time greater than the preset Loop Timer value. The control output will be turned off and the failure will be indicated by the lower display flashing LoOP. Loop Alarm Output (Output #3, #4, or #5) will be activated if selected.</p>		
<u>Probable Cause</u>	<u>Control Output Response</u>	<u>Display</u>
Sensor loses contact with process	Turns control output off	 Flashing
<p>If the sensor loses contact with the process (sensor becomes dislodged or pulled loose), the Loop Alarm will be activated when the process variable goes outside of the proportional band for a time greater than the preset Loop Timer value. The failure will be indicated by the lower display flashing LoOP. Loop Alarm Output (Output #3, #4, or #5) will be activated if selected.</p>		
<u>Probable Cause</u>	<u>Control Output Response</u>	<u>Display</u>
Sensor fails (open circuit)	Defaults to preset (0-100%)	 Flashing
<p>If the sensing device fails open, the controller defaults to the preset output condition (0-100% <math>\overline{ON}</math> setting selected on the <math>\overline{Ctrl}</math> <math>\overline{PRSE}</math> menu) and uses both displays to indicate OPEN SENS. The Loop alarm is not activated for this condition. Alarms selected as Low, High-Low, + Deviation or +/- Deviation will actuate if selected.</p>		

(continued on the next page)

Figure 6.1 CLP Loop Alarm Conditions (continued)

<b>Probable Cause</b>	<b>Control Output Response</b>	<b>Display</b>
Sensor fails (short circuit, RTD only)	Defaults to preset (0-100%)	 Flashing
<p>If the RTD sensing device fails shorted, the controller defaults to the preset output condition (0-100% <math>\overline{0-100\%}</math> setting selected on the <math>\overline{CLP}</math> <math>\overline{PSET}</math> menu) and uses both displays to indicate OPEN SENS. The Loop alarm is not activated for this condition. Alarms selected as Low, High-Low, - Deviation or +/- Deviation will actuate if selected.</p>		
<b>Probable Cause</b>	<b>Control Output Response</b>	<b>Display</b>
Controller Self Diagnostic (signal conversion)	Defaults to preset (0-100%)	 Flashing
<p>If a failure occurs in the signal conversion circuit of the controller, the controller defaults to the preset output condition (0-100% <math>\overline{0-100\%}</math> setting selected on the <math>\overline{CLP}</math> <math>\overline{PSET}</math> menu) and displays Err4 on the lower display. Loop Alarm Output (Output #3, #4, or #5) will be activated if selected.</p>		
<b>Probable Cause</b>	<b>Control Output Response</b>	<b>Display</b>
Controller Self Diagnostic	Turns control output off	 Flashing
<p>If a failure occurs in the control circuitry of the controller, the control output will be turned off and Err3 will be displayed on the lower display. Loop Alarm Output (Output #3, #4, or #5) will be activated if selected.</p>		



## Section 7

### Digital Input and AUX Function

---

The 2104 controller gives you two different options for actuation of any one of several field-selectable controller functions:

1. A Digital Input that is hardwired to terminals 1 and 2 of the controller.
2. The AUX pushbutton located on the controller front faceplate.

You may choose to use either the Digital Input or the AUX pushbutton, but you cannot use both.

#### Digital Input

The Digital Input allows you to use a remote switch, pushbutton or contact to perform any one of seven possible functions:

- PID1/PID2 Switch
- Output Disable/Enable
- SP/AUX Setpoint Switch
- Ramp/Soak
- Local/Remote Setpoint Switch
- Alarm Reset
- Auto/Manual Control Switch

The external switching device is connected to the controller Digital Input at terminals 1 and 2 (see page 10 for wiring instructions). The Digital Input function is selected in the **Ctrl PAGE** programming.

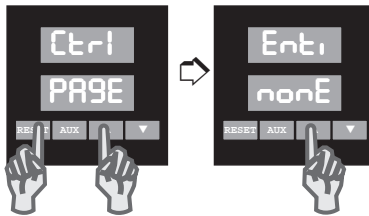

When the Digital Input is used, the AUX (Auxiliary) LED on the controller front panel is used for indication of the Digital Input function.

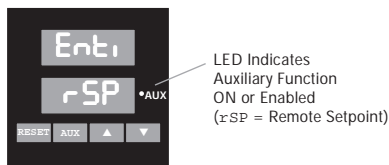

## AUX Pushbutton

The AUX front panel pushbutton can be assigned to perform any one of six possible functions and the AUX LED is used for indication of that function. Like the Digital Input, its function is selected in the **CTRL** **PARAM** programming. No wiring or hardware adjustments are required to use the AUX pushbutton as a function key.

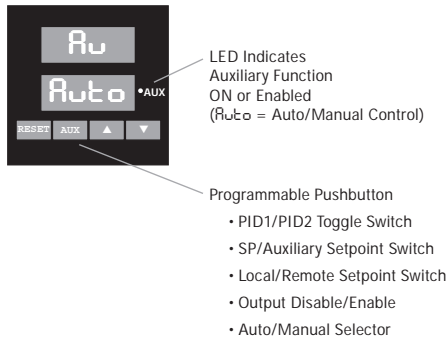

### Remember:

- The Digital Input and AUX function pushbutton cannot be used at the same time.
- If the AUX pushbutton is set to **RAMP/Soak**, it will display the Ramp/Soak Program Status when pressed. **45**
- When the AUX function = **RAMP/Soak**, the Digital Input can be used.

## Digital Input



### **nonE = None**

When disabled, the Digital Input has no effect on controller operation. If the AUX key is also disabled, the AUX light is used to indicate the output state (ON or OFF) of Output #5, if the controller has Output #5.

### **Pid2 = Enable**

This function can be used in single output control applications only (Ctrl PAGE, cont = HEAT or COOL). When this function is selected, the controller uses PID1 parameters (Ctrl PAGE) when the Digital Input switch is open. The PID2 parameters will be used when the switch is closed. The AUX indicator is ON when PID2 parameters are selected and OFF when PID1 parameters are selected.

### **AuSP = Auxiliary Setpoint Enable**

When this function is selected, the controller uses the Local Setpoint (Ctrl PAGE, SP) when the Digital Input switch is open. The Auxiliary Setpoint (Ctrl PAGE, AuSP) is used when the switch is closed. The AUX indicator is ON when the Auxiliary SP is selected and OFF when the Local Setpoint is selected. The setpoints are adjustable in the Operator Mode according to security. This function cannot be used when Ramp/Soak is enabled.

### **rSP = Remote SP Enable**

When this function is selected, the controller uses the Local Setpoint (Ctrl PAGE, SP) when the Digital Input switch is open. The Remote Setpoint is used when the switch is closed. Remote Setpoint must be enabled (Ctrl PAGE, rSP = ON) for this function to operate. The AUX indicator is ON when the Remote Setpoint is selected and OFF when the Local Setpoint is selected. This function cannot be used when Ramp/Soak is enabled.

## Digital Input (continued)



### **Outd = Output Disable**

When this function is selected, the control output(s) are enabled when the Digital Input switch is open, and disabled, when the switch is closed. The AUX indicator is ON, when the control output(s) are disabled and OFF, when enabled.

**Note:** Disabling the outputs allows all control parameters to be set up without starting the process.



**This setting is NOT intended for process shutdown. An external disconnect should be used for process shutdown.**



### **rS = Ramp/Soak**

This function allows the Digital Input to act as a Start/Stop and Hold button for controlling Ramp/Soak operation:

- Ramp/Soak operation is started when the Digital Input switch is closed (100 milliseconds), then opened (momentary action) while in Standby Mode.
- In Run Mode, this action will skip to the next interval.
- Hold Mode is entered by closing the Digital Input switch for 2 seconds while the program is running.
- Momentarily closing (100 milliseconds) the input switch while in HOLD will continue the program.
- Closing the Digital Input Switch for 2 seconds while in Hold Mode will stop the program and return to Standby.

## Digital Input (continued)

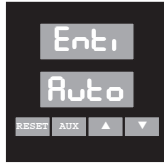

31

### **Auto = Auto/Manual Control**

This function allows the Digital Input to act as an Auto/Manual Control selector. Manual operation is selected when the Digital Input switch is closed. Automatic operation is selected when the switch is open. The AUX light is ON in Manual, and OFF in Automatic Mode.

### **Alarm Reset**

This function allows the Digital Input switch to be used as a remote Alarm Reset button for use with latching type alarms. The AUX light is used to indicate the state (ON or OFF) of Output #5, if the Output #5 option is installed in the controller.

## AUX Key



The AUX Key can be setup for any of the functions listed below:

### **None = None**

When disabled, the AUX Key has no effect on controller operation. AUX can be used to display the Ramp/Soak status, if Ramp/Soak is enabled. If the Digital Input is also disabled, the AUX light is used to indicate the state (ON or OFF) of Output #5, if installed.

## AUX Key (continued)

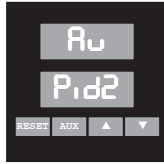

### **PID2 = PID2 Enabled**

This function can be used in single output control applications only (CET-1 PAGE CONT = HEAT or COOL). When this function is selected, pressing the AUX Key will toggle between PID1 (CET-1 PAGE, menus P<sub>b1</sub>, R<sub>r1</sub>, r<sub>A1</sub>) and PID2 (CET-1 PAGE, menus P<sub>b2</sub>, R<sub>r2</sub>, r<sub>A2</sub>) parameters. If the power is interrupted, the last active PID parameters will be used when power is restored. The AUX indicator is ON when PID2 parameters are selected and OFF when PID1 parameters are selected.

### **AUX SP = Auxiliary Setpoint Enable**

When this function is selected, pressing the AUX Key will toggle between the Auxiliary and Local setpoints. If the power is interrupted, the last active setpoint will be used when power is restored. The AUX indicator is ON when the Auxiliary Setpoint is selected and OFF when the Local Setpoint is selected. The setpoints are adjustable in Operator Mode according to security. This function cannot be used when Ramp/Soak is enabled.

### **rSP = Remote Setpoint Enable**

When this function is selected, pressing the AUX Key will toggle between the Remote and Local Setpoints. If the power is interrupted, the last active setpoint will be used when power is restored. Remote setpoint must be enabled (CET-1 PAGE, rSP = ON) for this function to operate. The AUX indicator is ON when the Remote Setpoint is selected and OFF when the Local Setpoint is selected. This function cannot be used when Ramp/Soak is enabled.

## AUX Key (continued)

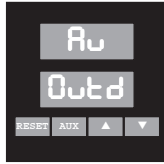

### **Outd = Output Disable**

When this function is selected, pressing the AUX Key will toggle between outputs enabled and outputs disabled. The AUX indicator is ON when the control output(s) are disabled and OFF when enabled.

**Note:** Disabling the outputs allows for all the parameters to be set without starting the process.



**This setting is not intended for shutdown of the process. An external disconnect should be used.**

**31**

### **Auto = Auto/Manual**

When this function is selected, pressing the AUX Key toggles between Manual and Automatic operation with Automatic as default at powerup. The AUX light is ON in Manual Mode, and OFF in Automatic Mode.



## Section 8 Remote Setpoint & Analog Output Option

---

### Remote Setpoint

The Remote Setpoint standard feature allows an external device to control the setpoint of the controller. The Remote Setpoint input accepts either 4-20mA or 1-5 Vdc input signals, selectable by a switch on the bottom of the controller. The Digital Input or AUX pushbutton can be set up to switch between the Local Setpoint and the Remote Setpoint.

#### To Select the Remote Setpoint Input Signal

Locate switch #4 on the bottom of the controller, as shown in Figure 8.1. Place the switch in the desired position.

Figure 8.1  
Remote Setpoint Input Signal

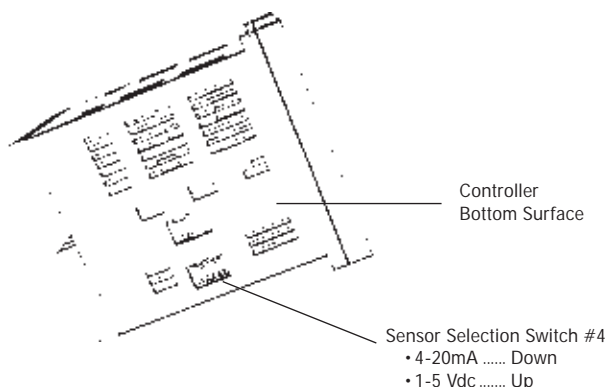

#### To Enable the Remote Setpoint

Go to MENU rSP on the Ctrl PAGE and select ON.

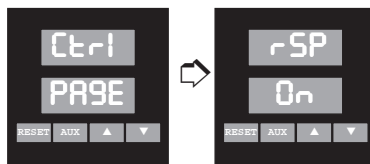

**Note:** The Digital Input or AUX pushbutton can be used to switch between Remote Setpoint and Local Setpoint (see page 57 for setup).

## To Scale the Input Signal

Go to the **ScAL PAGE**, **MENU**s **rSPL** (remote setpoint low) and **rSPH** (remote setpoint high). Enter the sensor span low and high ranges. For example, for a 100 to 500°F range, 4mA would equal 100°F setpoint, and 20mA would equal 500°F setpoint.



This page appears only if Remote Setpoint and/or Analog Process Output are Enabled.

### Custom Scaling Page

MENU	Description	Available Settings	Security
<b>rSPL</b>	Remote Setpoint-Low	Instrument Sensor Span	C
<b>rSPH</b>	Remote Setpoint-High	Instrument Sensor Span	C

## Remote Setpoint Wiring

Figure 8.2  
2-Wire 4-20mA  
Transmitter  
(Loop-Powered)

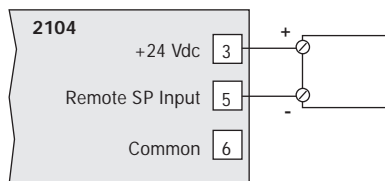

Figure 8.3  
2-wire 4-20mA,  
1-5 Vdc Transmitter  
(Self-Powered)

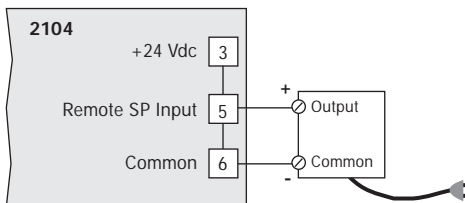
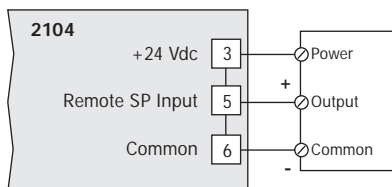

Figure 8.4  
3-wire 4-20mA,  
1-5 Vdc Transmitter



## Analog Output Option

The Analog Output Option is provided on controllers with model number

- 2104 - \*\*\*3\*
- 2104 - \*\*\*4\*
- 2104 - \*\*\*5\*

This option can be used to transmit any one of four process parameters:

- Proc ..... Process Variable
- RSP ..... Active Setpoint
- Out1 ..... Output #1 Command (%ON)
- Out2 ..... Output #2 Command (%ON)

The variable can be transmitted to a remote recorder, computer or other device via a 4-20mA or 1-5 Vdc signal, selectable by a switch on the bottom of the controller.

### To Select the Analog Process Output Signal

Locate switch #5 on the bottom of the controller, as shown in Figure 8.2. Place the switch in the desired position.

Figure 8.5  
Analog Output  
Signal

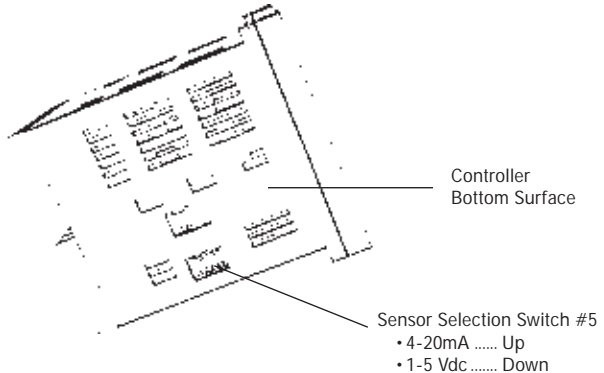

### To Enable the Analog Output Option:

Go to MENU ROOT on the CTRL PAGE and select one of the 4 parameters.

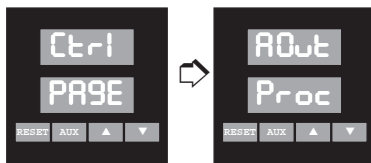
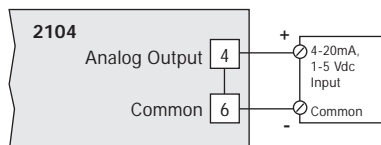

Figure 8.6  
Process  
Output Wiring



### To Scale the Output Signal

When the Process Variable or Active Setpoint is selected for transmission, the output signal is scaled using the Analog Output scaling MENUs. Go to the SCAL PAGE, MENU ROOT (analog output low) and ROOTH (analog output high). Enter the output signal range to be sent to your recorder or computer (i.e., 100 = 4mA and 500°F = 20mA).



#### Custom Scaling Page

MENU	Description	Available Settings	Security
ROOTL	Analog Process Output - Low	Instrument Sensor Span	C
ROOTH	Analog Process Output - High	Instrument Sensor Span	C

When Output #1 or Output #2 are selected for transmission, the low end of span (4mA or 1 Vdc) represents 0.0% output, and the high end of span (20mA or 5 Vdc) represents 100.0% output.

The Digital Communications option is provided on the following controllers:

<u>Model</u>	<u>Communications</u>
2104 - ***2*	RS232
2104 - ***5*	RS232
2104 - ***1*	RS485/422
2104 - ***4*	RS485/422

The Digital Communications option gives the 2104 the ability to interface with computers using either Chromalox's Computer Interface mode or ASCII Line mode. These modes implement communications that can address up to 255 Chromalox controllers on an RS422A/RS485 multidrop line. The protocols for these two modes are described in the Digital Communications User's Manual (P/N 0037-75129) that is supplied with controllers containing the Digital Communication option.

### **ChromaSoft™**

If a prepackaged software program is preferred for multidrop digital communication with up to 255 Chromalox controllers, Chromalox offers *ChromaSoft* remote operator interface software. *ChromaSoft* is DOS-based and communicates with the controllers via a serial interface port. Instructions for using *ChromaSoft* are given in the User's Manual provided with the software.

### **Hardware Setup**

RS232 can be used to connect a computer or modem to a single 2104 controller. RS232 lines can be run over distances up to 50 feet.

RS422 and RS485 provide multidrop network communications where up to 255 controllers can communicate with a single computer at a distance of up to 4000 feet.

## Hardware Setup (continued)

When shipped from the factory, the multidrop communications interface is set for RS422. If you are using RS485, two switches in the controller hardware must be positioned for the communications interface. Locate the switches on the bottom of the controller and position them as shown in Figure 9.1.

Figure 9.1  
RS422/RS485  
Communications  
Switches

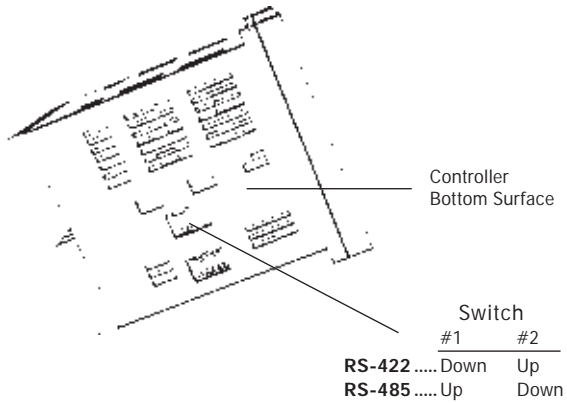

## Digital Communications Wiring

Wiring connections for the digital communications interface are made on terminals 9-13 using shielded serial interface cable.

Figure 9.2  
RS232 Wiring  
Connections

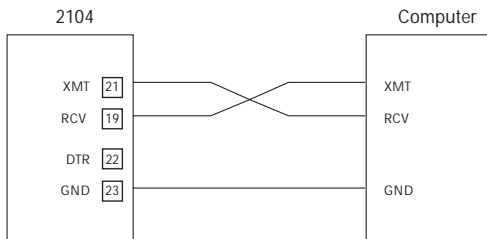

**Note:** The DTR output is always enabled when the 2104 power is on.

Figure 9.3  
RS422A Wiring Connections (4-wire)

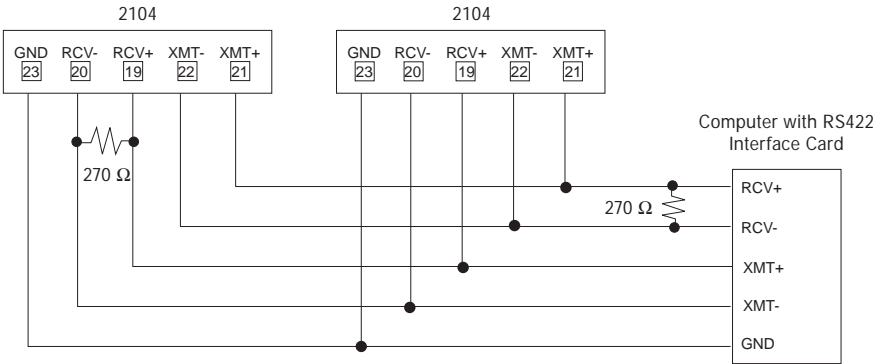

**Note:** 270  $\Omega$  resistors recommended across receive line on computer and last controller.

Figure 9.4  
RS485 Wiring Connections (2-wire)

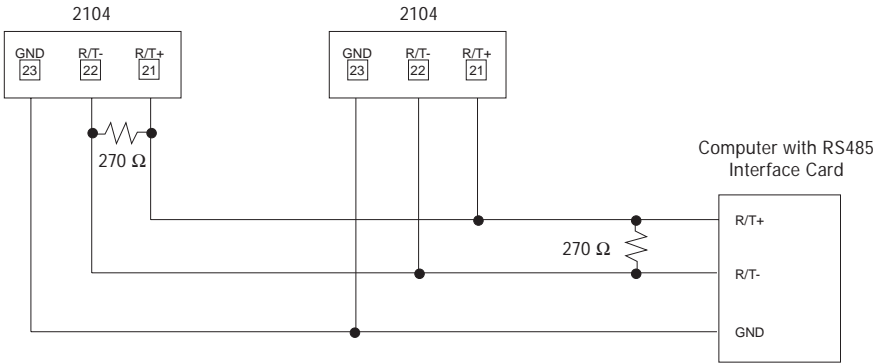

**Note:** 270  $\Omega$  resistors recommended across receive line on computer and last controller.

## Digital Communications Programming and Setup

All programmed selections are made on the **DIS PAGE** of the controller.



This setup PAGE appears only if the controller is equipped the digital Communications option.

### Digital Communications Page: DIS PAGE

<u>MENU</u>	<u>Description</u>	<u>Available Settings</u>	<u>Security</u>
<b>DIS</b>	Mode Selection	OFF = Disabled CIP = Computer Interface LINE = ASCII Line	C
<b>BAUD</b>	Baud Rate	1200 2400 4800 9600 19.2K	
<b>ADDR</b>	Address	1 to 255	

In this section you will find calibration instructions for calibrating:

- *Sensor Input*
- *Remote Setpoint Input*
- *Analog Output*

Instructions are also given for:

- *Factory Calibration Recovery*
- *Calibration Offset*

### **When is Calibration Required?**

The 2104 controller is factory calibrated before shipment to you, therefore, it is not necessary to calibrate the controller when you receive and install it. Periodic calibration checks or adjustments of the unit should not be required under normal operating conditions. Chromalox recommends that you recalibrate the controller in the following instances:

- all instruments in your facility are periodically calibrated to one device (metrology)

## Important Calibration Notes

1. Disconnect load power when calibrating or disable the control output using the **AUX** pushbutton.
2. RTD inputs should be calibrated using copper (Cu) wire, and thermocouple inputs should be calibrated using thermocouple extension wire of the same type as the thermocouple you are calibrating.
3. Substitute a precision sensor simulator (thermocouple simulator or resistance decade box) for the sensor inputs. The controller should be allowed to warm-up with the appropriate sensor simulator connected for at least one hour prior to calibration.
4. To access the calibration, you will need to be at LEVEL D security. Enter Security Code "736" at menu LOCK on the CRT PAGE.

## Sensor Input Calibration

The sensor input of the 2104 can be calibrated using an appropriate sensor simulator and the Sensor Calibration menu on the Input Page.



1. Connect the sensor simulator to the sensor input terminals.
2. Go to menu CALS. The lower display will show **inLo**, indicating that you should first calibrate the sensor low end.



**Sensor  
Input  
Calibration**  
(continued)

3. Adjust the simulator to output the low end of the selected sensor range. Sensor minimum ranges are:

<u>Sensor</u>	<u>°F</u>	<u>°C</u>
J T/C	-100	-73
K T/C	-300	-184
T	-350	-212
E	-100	-73
R	0	-18
S	0	-18
B	50	10
RTD	48.46Ω	
RTD (0.1°)	70.98Ω	
4-20mA	4mA	
0-5 Vdc	0 Vdc	
1-5 Vdc	1 Vdc	

4. Wait 30 seconds for the electronics to fully stabilize. Press **▲**. Dashes will appear in the lower display while the controller calibrates the low end of span.

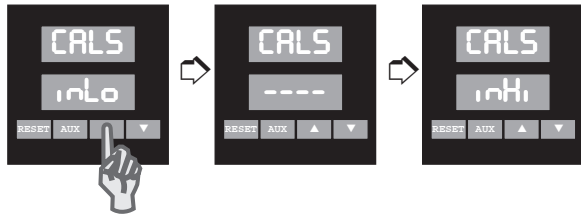

5. When the controller prompts **inHi** in the lower display, adjust the sensor simulator to output the high end of the currently selected sensor span. Sensor maximum ranges are:

<u>Sensor</u>	<u>°F</u>	<u>°C</u>
J T/C	1400	760
K T/C	2400	1316
T	750	399
E	1100	593
R	3200	1760
S	3200	1760
B	3300	1816
RTD	293.49Ω	
RTD (0.1°)	275.04Ω	
4-20mA	20mA	
0-5 Vdc	5 Vdc	
1-5 Vdc	5 Vdc	

## Sensor Input Calibration (continued)

6. Wait 30 seconds for the electronics to stabilize. Press ▲. Dashes will appear in the lower display while the controller calibrates the high end of span. When finished, the controller will display done.

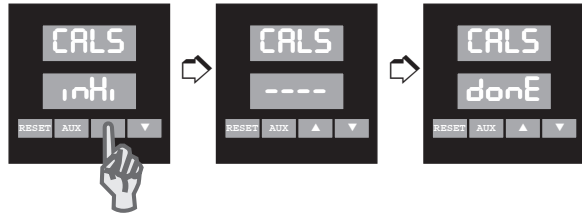

7. Press RESET to exit calibration.

## Remote Setpoint Input Calibration

The Remote Setpoint Input is calibrated using an appropriate 4-20mA or 1-5 Vdc simulator. Calibration is performed in the menu `CALr` on the Input Page.

1. Connect the simulator to the remote setpoint input terminals.
2. Go to menu `CALr`. The lower display will show `inLo`, indicating that you should first calibrate the input low end (4mA or 1 Vdc).



**Remote  
Setpoint  
Input  
Calibration**  
(continued)

- Adjust the simulator to output the low end of the selected range. Wait 30 seconds for the electronics to fully stabilize. Press ▲. Dashes will appear in the lower display while the controller calibrates the low end of span.

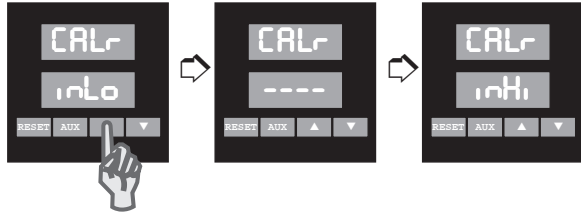

- When the controller prompts inHi in the lower display, adjust the simulator to output the high end of the currently selected input span (20mA or 5 Vdc).
- Wait 30 seconds for the electronics to stabilize. Press ▲. Dashes will appear in the lower display while the controller calibrates the high end of span. When finished, the controller will display done.

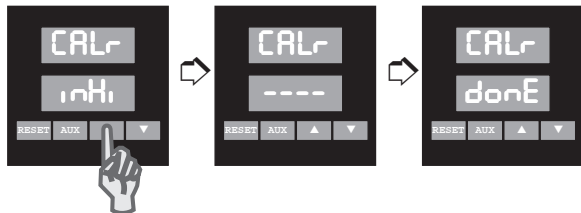

- Press RESET to exit calibration.

## Analog Output Option Calibration

The Analog Output signal is calibrated using an appropriate current or voltage meter. Calibration is performed in the two analog output calibration menus (R0 0 and R0 5) on the Input Page.

1. Connect the meter to the analog process output terminals. To calibrate the analog output, the output must be forced to the low end of span. If the setpoint is selected for transmission (CTRL PAGE, ROUT = RSP) this can be done by adjusting the setpoint to the low end of span (i.e. J T/C = -100°F).
2. Go to menu R0 0. Adjust the Analog Output (using ▲ and ▼) until the meter reads 4mA or 1.000 Vdc.

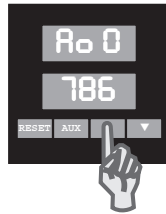

Note: The number displayed in the lower display page is for reference only.

3. Go to menu R0 0 = RSP and adjust the setpoint to the high end of span (i.e., for J T/C = 1400°F).
4. Go to menu R0 5. Adjust Analog Output (using ▲ and ▼) until the meter reads 20mA or 5.000 Vdc.

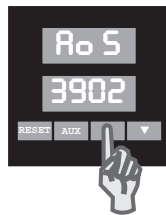

5. Press and hold **RESET** for 3 seconds to exit calibration mode.

## Factory Calibration Recovery

This option allows you to return the controller to its factory calibration settings in the event that it is severely out of calibration due to poor technique or unauthorized calibration. Although the factory calibration settings are recovered, this does not guarantee original calibration accuracy. The Factory Calibration Recovery should be used as a “starting point” for recalibration, should the unit become severely out of calibration.

Factory Calibration Recovery is performed on the **MPt PAGE**, menu **rECc**.



To reestablish the factory calibration constants:

1. Disconnect load power.
2. Go to menu **rECc** and press **▲**. The controller will automatically recalibrate.

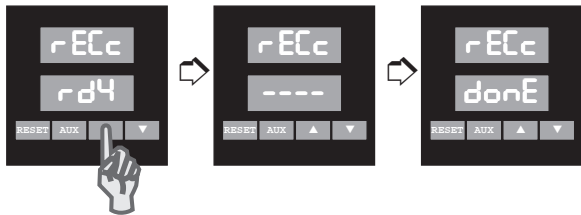

3. The lower display cycles from “----” to “done”. Press **RESET** to exit the calibration mode.

## Display Calibration Offset

If an offset on the temperature reading is desired, the Display/Calibration Offset menu may be used. In some applications, this offset may be desired to match another instrument or an inferred temperature in another part of the system.

To establish the calibration offset:

1. Go to menu CoFF on the Input Page.



2. Use ▲ and ▼ to set the calibration offset, adjustable from -100 to 100°F.



# Section 11

## Specifications

---

### Control Modes

Automatic	On/Off Proportional (P) PID-Proportional with Integral and/or Derivative (PID, PI, PD) PID + Fuzzy Logic Heat/Cool (Dual PID)
-----------	---

### Control Adjustments

Control Setpoint	Sensor Range
Setpoint Limits	Sensor Range
Deadband	1 to 100°F
Proportional Band	Sensor Range
Manual Reset	-99.9 to 99.9
Automatic Reset	0.00 to 99.99 repeats per minute
Rate	0 to 500 seconds
Output Cycle Time	0.1 to 60.0 seconds
Output Limit	0.0 to 100.0%
Open Sensor & Out of Range	
Output Command	0.0 to 100.0%
Display Offset	-100 to 100°F

### Heat/Cool Adjustments

Output Offsets	0 to 100% of Proportional Band
Cooling Medium	Air, Water or Oil

### Alarm Adjustments

Setpoints	High and Low Settings for each Alarm Output
Alarm Types	Absolute: High, Low and High/Low Tracking: + Deviation, - Deviation and +/- Deviation
Relay Action	Latching or Non-Latching, Energized or De-Energized
Alarm Deadband	Adjustable, 0 to 100°F
Alarm Inhibit	On Power-Up, Enabled or Disabled

### Control/Alarm Outputs

Relay	Total of five (5) Control/Alarm outputs possible Relay—Form A contacts, 1.0 Amps at 120/230 Vac (resistive)
Solid State Relay Drive	24 Vdc nominal at 40mA
Triac	1 Amp continuous, 10 Amp in-rush, at 120 or 230 Vac
Current/Voltage	4 to 20mA into 0 to 800Ω, field changeable to 1-5 Vdc

### Output #5 (Optional)

Relay—N.O. Form C contact, 5A at 120 or 2.5A at 230 Vac (resistive)

### Sensor Input

Field selectable Thermocouple, RTD, Current or Voltage

### Input Update Rate

2 Samples per Second



<b>Digital Input</b>	Accepts dry-contact closure
<b>Analog Output Option</b>	
Assignable Functions	Process Variable Active Setpoint Output #1 Command Output #2 Command
Output Signal	4-20mA into 0-800Ω load 1-5 Vdc into 100KΩ or greater load Selectable via DIP switch
Range	Programmable over selected sensor span for retransmission of Process Variable and Active Setpoint, fixed to 0 to 100% for transmission of output commands
Accuracy	±0.2% of programmed span, ±1 LSD
<b>Digital Communications (Optional)</b>	
RS-232	Single-drop, isolated
RS-422/485	Multi-drop, isolated, field selectable by switch
Baud rates	1200, 2400, 4800, 9600, 19.2K
Protocols	ASCII Line, Computer Interface
<b>Instrument Power</b>	100 to 240 Vac, +10%, -15%; 12 to 24 Vac/Vdc, ±10%; 50 to 60 Hz
<b>Operating Environment</b>	32 to 150°F (0 to 65°C) ambient temperature, relative humidity less than 95%, non-condensing
<b>Dimensions</b>	
Overall	3.8 x 3.8 x 4.75 inches (96 x 96 x 121mm)
Depth Behind Projection	4.0 inches (102 mm)
Front Panel Projection	0.75 inches (19 mm)
Panel Cutout	3.6 x 3.6 inches (92 mm x 92 mm)
<b>Case Material</b>	High Impact, Black ABS Plastic
<b>Front Panel</b>	NEMA 4X Construction
<b>Influence of Line Voltage Variation</b>	±0.1% of Sensor Span/10% change in nominal line voltage
<b>Noise Rejection</b>	
Common Mode Noise	140dB at 60 Hz
Series Mode Noise	±0.1% of Sensor Span with 300mV peak to peak, 50 or 60Hz series mode noise
RFI	Typically less than 0.5% of Sensor Span at a distance of 1 meter (3.1 feet) from transmitter (4W, 464Mhz)

**Sensor Leadwire Effect**

J Thermocouple	+1°F for 1000 Ft. of 18 AWG extension wire
K Thermocouple	+5°F for 1000 Ft. of 18 AWG extension wire
E Thermocouple	+4°F for 1000 Ft. of 18 AWG extension wire
R Thermocouple	+3°F for 1000 Ft. of 18 AWG extension wire
S Thermocouple	+3°F for 1000 Ft. of 18 AWG extension wire
B Thermocouple	+6°F for 1000 Ft. of 18 AWG extension wire
T Thermocouple	+1°F (temperatures > -80°C) +2°F (temperatures < -80°C)
RTD, 4-20mA, 1-5 Vdc	±0.1% of Sensor Span/20Ω balanced leadwire resistance

## Section 12 Troubleshooting

---

The following Troubleshooting Guide gives simple solutions to common problems, and explains the 2104's Error Messages. Should you have a problem with your controller, it is a good idea to check this Guide for possible corrections before contacting the factory. The corrections are listed in the order in which they should be performed.

**Note:** A specific List of Loop Alarms and probable causes are given on pages 55-57.

<b>Troubleshooting Guide</b>		
<b>Symptom</b>	<b>Probable Cause</b>	<b>Correction</b>
Power applied, display does not light and controller does not function	1. No power applied	1. Check power wiring and fusing 2. Power down and repower up
Display reads OPEN SENS	1. Open sensor 2. Out of calibration	1. Check sensor wiring (page 7) 2. Check sensor type selected at OPEN PASE, SENS 3. Recover Factory Calibration (page 81) 4. Attach sensor simulator and verify calibration (page 76) 5. Check "Control Loop Protection" Alarm
Process does not heat up	1. No power being applied to the load	1. Verify output wiring (page 11) 2. Verify that load is not open and output jumpers are properly installed 3. Check "control type" entered at Ctrl PASE, Cont (Heat, Cool or Heat Cool) 4. Check "output limit" entered on OUT1/OUT2 PASE, OL1/OL2
Erratic operation	1. Intermittent sensor connections 2. Controller failure (internal electronics)	1. Check sensor wiring or substitute sensor simulator 2. Power down and repower up 3. Contact factory

continued on next page

## Troubleshooting Guide

Symptom	Probable Cause	Correction
Process not in control	<ol style="list-style-type: none"> <li>1. Incorrect "control action" selected</li> <li>2. Not tuned correctly</li> </ol>	<ol style="list-style-type: none"> <li>1. Check "control type" entered <code>Ctrl PRSE, Cont</code></li> <li>2. See Self-Tuning and PID settings, <code>Ctrl PRSE</code></li> </ol>
Instrument continually goes through power-up reset	<ol style="list-style-type: none"> <li>1. Internal electronic failure</li> <li>2. Drastic power line anomalies</li> </ol>	<ol style="list-style-type: none"> <li>1. Contact factory</li> </ol>
Err3 displayed with PRSE in lower display	<ol style="list-style-type: none"> <li>1. EEPROM failed redundancy check</li> </ol>	<ol style="list-style-type: none"> <li>1. Power down and back up to retest EEPROM</li> <li>2. Set controller to Level D (736) Security Code.</li> <li>3. Go to PRSE shown. Use RESET pushbutton to scroll through all menus. Readjust any settings that appear incorrect. After scrolling through all menus, error will clear.</li> </ol>
Err4 displayed	<ol style="list-style-type: none"> <li>1. A to D electronics failure</li> </ol>	<ol style="list-style-type: none"> <li>1. Power down and up to reset</li> <li>2. Consult factory</li> </ol>
Err flashing on upper or lower display	<ol style="list-style-type: none"> <li>1. Self-tune was enabled, but unable to successfully tune because:             <ol style="list-style-type: none"> <li>a. process could not get 50°F below setpoint (for heating) or 50° above setpoint (for cooling) in 30 minutes</li> <li>b. over a 10 hour period, the process has not changed enough to initiate turning</li> <li>c. process went in and out of sensor range during tune.</li> <li>d. 2104 is unable to calculate PID parameters</li> </ol> </li> </ol>	<ol style="list-style-type: none"> <li>1. Press RESET to clear error. Previous PID parameters are retained</li> <li>2. Consult factory</li> </ol>
Loop error	See pages 55-57	<ol style="list-style-type: none"> <li>1. Press RESET to clear error</li> <li>2. Verify wiring and external devices</li> </ol>

**Warranty**

Chromalox warrants only that the Products and parts manufactured by Chromalox, when shipped, and the work performed by Chromalox when performed, will meet all applicable specification and other specific product and work requirements (including those of performance), if any, and will be free from defects in material and workmanship under normal conditions of use. All claims for defective or nonconforming (both hereinafter called defective) Products, parts or work under this warranty must be made in writing immediately upon discovery, and in any event, within three (3) years from delivery, provided, however all claims for defective Products and parts must be made in writing no later than thirty-six (36) months after shipment by Chromalox. Defective and nonconforming items must be held by Chromalox's inspections and returned to the original f.o.b. point upon request. THE FOREGOING IS EXPRESSLY IN LIEU OF ALL OTHER WARRANTIES WHATSOEVER, EXPRESSED, IMPLIED AND STATUTORY, INCLUDING, WITHOUT LIMITATION, THE IMPLIED WARRANTIES OF MERCHANTABILITY AND FITNESS FOR A PARTICULAR PURPOSE.

**Limitations**

Notwithstanding the provisions of this WARRANTY AND LIMITATIONS Clause, it is specifically understood that Products and parts not manufactured and work not performed by Chromalox are warranted only to the extent and in the manner that the same are warranted to Chromalox by Chromalox's vendors, and then only to the extent that Chromalox is reasonably able to enforce such a warranty, it being understood Chromalox shall have no obligation to initiate litigation unless buyer undertakes to pay all cost and expenses therefore including but not limited to attorney's fees, and indemnifies Chromalox against any liability to Chromalox's vendors arising out of such litigation.

Upon buyer's submission of a claim as provided above and in its substantiation, Chromalox shall at its option either (i) repair or replace its Products, parts or work at the original f.o.b. point of delivery or (ii) refund an equitable portion of the purchase price.

The foregoing is Chromalox's only obligation and buyer's exclusive remedy for breach of warranty, and is buyer's exclusive remedy against Chromalox for all claims arising hereunder or relating hereto whether such claims are based on breach of contract, tort (including negligence and strict liability) or other theories, buyer's failure to submit a claim as provided above shall specifically waive all claims for damages or other relief, including but not limited to claims based on latent defects. In no event shall buyer be entitled to incidental or consequential damages and buyer should hold Chromalox harmless therefrom. Any action by buyer arising hereunder or relating hereto, whether based on breach of contract, tort (including negligence and strict liability) or other theories, must be commenced within one (1) year after the date of shipment or it shall be barred.

## **Returns**

Items returned to Chromalox Instruments and Controls must be accompanied by a Return Authorization Number. This number may be obtained from Chromalox Instruments and Controls, Customer Service Department, Telephone Number (615) 793-3900. It should appear on the exterior of the shipping carton and on the shipping documents. Defective items will be repaired or replaced at our option, at no charge.

Return the defective part or product, freight prepaid, to:

Chromalox Instruments and Controls  
1382 Heil-Quaker Blvd.  
LaVergne, TN 37086-3536

# Appendix 1

## PAGE/MENU Tables

---

Setup Page	PAGE Name	PAGE Contents
<b>dSP</b>	Display	Allows you to monitor any of 11 real time variables in the lower digital display; process variable; setpoint; outputs; timers and alarm status. This is useful during troubleshooting or brief trending periods. Values on this page are for display only and cannot be changed on this PAGE.
<b>Ctrl</b>	Control	Security Lock Setpoints Self Tune PID1 and PID2 Control Parameters Manual Reset Fuzzy Logic Output Commands Control Loop Protection (CLP) Auto/Manual Disintegration Timer Ramp Rate Controller Type Cooling Medium Event/Digital Function Auxiliary Pushbutton Function Analog Output assignment Ramp/Soak User Selected Security Code
<b>inPt</b>	Input	Sensor Type Display Units Display/Calibration Offset Setpoint Low Limit Setpoint Upper Limit
<b>ScAL</b>	Custom Scaling	Analog Input Decimal Points Analog Input Low Analog Input High Analog Output High Remote Setpoint Input Low Remote Setpoint Input High
<b>Out1</b>	Output #1	Output #1 Cycle Time Output #1 Limit Heat Offset
<b>Out2</b>	Output #2	Output #2 Cycle Time Output #2 Limit Heat Offset

## Security Levels

See pages 26-27 for details.

### Security Levels and PAGE/MENU Contents

Level	Code	Description
<b>A</b>	---	Display Page and Security Lock
<b>B</b>	123	Setpoint and Auxiliary Setpoint
<b>C</b>	458	Settings for: Control Input Ramp/Soak Digital Communications
<b>D</b>	736	Calibration Security Codes

## Security Codes

### Security Codes

Security <u>Level</u>	Security <u>Code</u>	View <u>Level</u>	Adjust <u>Level</u>
<b>A</b>	---	A	A
<b>B</b>	<b>123</b>	A, B	A, B
<b>C</b>	<b>458</b>	A, B, C	A, B, C
<b>D</b>	<b>736</b>	A, B, C, D	A, B, C, D

See pages 35-37 for details.

Control Page				
Menu	Description	Available Settings	Factory Settings	Security
<b>LoCh</b>	Security Lock	0 to 9999	458	A
<b>SP</b>	Setpoint	Instrument sensor span	Span Low	B
<b>AuSP</b>	Auxiliary SP	Instrument Sensor Span	Span Low	
<b>tunE</b>	Self Tune	OFF = Self tuning disabled PrUP = Powerup tuning BEgn = Begin tuning	OFF	C
<b>Pb1</b>	Proportional Band 1	0°F to sensor range	25°F	
<b>Rr1</b>	Automatic Reset 1	0.00 to 99.99 repeats/minute	0.10	
<b>rRt1</b>	Rate 1	0 to 500 seconds	10	
<b>db1</b>	Dead Band 1	1 to 100°F 0.01 to 6.25% span for analog inputs	5°F	
<b>Pb2</b>	Proportional Band 2	0°F to sensor range	25°F	
<b>Rr2</b>	Automatic Reset 2	0.00 to 99.99 repeats/minute	0.10	
<b>rRt2</b>	Rate 2	0 to 500 seconds	10	
<b>db2</b>	Dead Band 2	1 to 100°F 0.01 to 6.25% span for analog inputs	5°F	
<b>OFFst</b>	Manual Reset	-99.9 to 99.9	0.0	
<b>FL</b>	Fuzzy Logic	OFF = Disabled On = Enabled	On	
<b>Grn9</b>	Open Sensor Output Command	For Heat/Cool Control, adjustable: -100.0 to 100.0%: -100.0 to -0.1 for cooling 0.1 to 100.0 for heating	0.0%	
<b>Loop</b>	Control Loop Protection	OFF, 0.1 to 999.9 minutes	OFF	
<b>Auto</b>	Auto/Manual Disintegration Timer	0 to 100 seconds	10	
<b>rRt</b>	Ramp Rate	OFF	OFF	

## Control Page

See pages 35-37 for details.

Control Page (continued)				
Menu	Description	Available Settings	Factory Settings	Security
<b>Cont</b>	Controller Type	HERt = Reverse Acting Output Controller	HERt	C
		COOL = Direct Acting Single Output Controller		
		HEtC = Heat/Cool Controller		
<b>COOL</b>	Cooling Medium	Pid2 = Uses PID2 settings for cooling	Pid2	
		Air = Air Cooling		
		Oil = Oil Cooling H2O = Water Cooling		
<b>rSP</b>	Remote Setpoint Enable	OFF On	OFF	
<b>Ent1</b>	Event/Digital Function	nonE = Disabled	nonE	
		Pid2 = PID2 enable		
		AuSP = Auxiliary SP enable		
		rSP = Remote SP enable		
		Outd = Output disable		
		rS = Ramp/Soak		
		Auto = Auto/Manual		
Alr = Alarm Reset				
<b>Au</b>	Auxiliary Pushbutton Function	nonE = Disabled	nonE	
		Pid2 = PID2 enable		
		AuSP = Auxiliary SP enable		
		rSP = Remote SP enable		
		Outd = Output disable		
		Auto = Auto/Manual		
<b>Out</b>	Analog Output Assignment	nonE = Disabled	RSP	
		Proc = Process Variable		
		RSP = Active Setpoint		
		Out1 = Control Output !		
		Out2 = Control Output 2		
<b>rSEn</b>	Ramp/Soak	OFF On	OFF	
<b>Code</b>	User Selected Security Code	0-122 = Level A 123-457 = Level B 458-735 = Level C 736-999 = Level D	0	D

See pages 41-45 for details.

Ramp/Soak Page				
MENU	Description	Available Settings	Factory Settings	Security
<b>unit</b>	Time Units	SEc = seconds (1 to 9999) min = minutes (0.1 to 999.9) hr = hours (0.01 to 99.99)	SEc	C
<b>Stb4</b>	Standby Setpoint	Instrument Sensor Span	Span Low	
<b>int1</b>	Interval 1 Time	see Time Units Menu (above)	0	
<b>SP1</b>	Setpoint 1 • Intervals 2-15 • Time and Setpoint	Instrument Sensor Span	Span Low	
<b>int16</b>	Interval 16 Time	see Time Units Menu (above)	0	
<b>SP16</b>	Setpoint 16	Instrument Sensor Span	Span Low	
<b>Cont</b>	Continuous Program	OFF On	OFF	
<b>Fro</b>	Loop from the end of interval	1 to 16	1	
<b>to</b>	To the beginning of interval	1 to 16	1	
<b>no</b>	Number of times	0 to 9999	0	
<b>StbEt</b>	Standby Events	OFF = All off E3 = Event Output 3 On E4 = Event Output 4 On E43 = Event Outputs 4 & 3 On E5 = Event Output 5 On E53 = Event Outputs 5 & 3 On E54 = Event Outputs 5 & 4 On E543 = Event Outputs 5, 4, 3 On	OFF	
<b>int1E</b>	Interval 1 Events	OFF = All off E3 = Event Output 3 On E4 = Event Output 4 On E43 = Event Outputs 4 & 3 On E5 = Event Output 5 On E53 = Event Outputs 5 & 3 On E54 = Event Outputs 5 & 4 On E543 = Event Outputs 5, 4, 3 On	OFF	
<b>int16E</b>	Interval 16 Events	same as above	OFF	
<b>GSdb</b>	Guaranteed Soak differential	OFF, 1°F to sensor range	0°F	

# Input Page

See page 38 for details.

Input Page		Available Settings	Factory Settings	Security
<b>SEnS</b>	Sensor Type	Sensor Type selected here must agree with dip switch settings. J = J Thermocouple K = K Thermocouple T = T Thermocouple E = E Thermocouple R = R Thermocouple S = S Thermocouple B = B Thermocouple RTD = 100Ω Pt RTD (a = .00385) 4-20 = 4 to 20mA 0-5 = 0 to 5 Vdc 1-5 = 1 to 5 Vdc rtdt = 100Ω Pt RTD (0.1° resolution)	J	C
<b>unit</b>	Display Units	noE = no units °F = Degrees Fahrenheit °C = Degrees Celsius	°F	
<b>CoFF</b>	Display/ Cal. Offset	-100°F to 100°F	0	
<b>SPLL</b>	Setpoint Low Limit	Instrument Sensor Span	Span Low	
<b>SPUL</b>	Setpoint Upper Limit	Instrument Sensor Span	Span High	
<b>CALS</b>	Sensor Calibration	inLo inHi doneE	inLo	D
<b>CALr</b>	Remote Setpoint Calibration	inLo inHi doneE	inLo	
<b>RoO</b>	Analog Output Zero Calibration	0 to 4095		
<b>RoS</b>	Analog Output Span Calibration	0 to 4095		
<b>rECc</b>	Factory Calibration Recovery	rdY = Ready --- = Wait doneE = Finished		
<b>Flt</b>	Digital Filter	0 to 60 seconds		
<b>hPrC</b>	High (max.) Process Input	Instrument Sensor Span		
<b>LPrc</b>	Low (min.) Process Input	Instrument Sensor Span		
<b>hiA</b>	High (max.) Ambient Temp.	Instrument Sensor Span		
<b>LoA</b>	Low (min.) Ambient Temp.	Instrument Sensor Span		

## Custom Scaling Page

See page 39 for details.

Custom Scaling Page				
<u>MENU</u>	<u>Description</u>	<u>Available Settings</u>	<u>Factory Settings</u>	<u>Security</u>
<b>DP</b>	Analog Input Decimal Pts.	0 = none 1 = 123.4 2 = 12.34 3 = 1.234	1	C
<b>PinL</b>	Analog Input Low	-500 to 5000	0.0	
<b>PinH</b>	Analog Input High	-500 to 5000	100.0	
<b>PotL</b>	Analog Output Low	-500 to 5000	Span Low	
<b>PotH</b>	Analog Output High	-500 to 5000	Span High	
<b>rSPL</b>	Remote SP Input Low	-500 to 5000	Span Low	
<b>rSPH</b>	Remote SP Input High	-500 to 5000	Span High	

## Output #1 Page

See page 39 for details.

Output #1 Page				
<u>MENU</u>	<u>Description</u>	<u>Available Settings</u>	<u>Factory Settings</u>	<u>Security</u>
<b>[4c]</b>	Output #1 Cycle Time	0.0 to 60.0 seconds	1.0*	C
<b>OL1</b>	Output #1 Limit	0.0 to 100.0%	100.0%	
<b>HoFF</b>	Heat Offset	0°F to PB1 setting	0	

\* For 2104-A (voltage or current output) cycle time must be set to 0.0.

## Output # 2 Page

See page 39 for details.

### Output #2 Page

<u>MENU</u>	<u>Description</u>	<u>Available Settings</u>	<u>Factory Settings</u>	<u>Security</u>
<b>04c2</b>	Output #2	0.0 to 60.0 seconds 0.0 = Voltage/Current algorithm	1.0	C
<b>0L2</b>	Output #2 Limit	0.0 to 100.0%	100.0%	
<b>H0FF</b>	Heat Offset	0°F to PB1 setting	0	

## Output # 3 Page

See page 50 for details.

### Output #3 Page

<u>MENU</u>	<u>Description</u>	<u>Available Settings</u>	<u>Factory Settings</u>	<u>Security</u>
<b>04P3</b>	Output #3 Type	OFF = Disabled Al r = Alarm Output EnE = Event Output (Setup Event Output parameters on Ramp/Soak Page)	OFF	C
<b>Al r3</b>	Alarm #3 Type	nonE = Disabled (off) Hi = High Alarm Lo = Low Alarm HiLo = High-Low Alarm PdE = Plus Deviation Alarm -dE = Minus Deviation Alarm dE = Plus/Minus Deviation Alarm Loop = Control Loop Protection Alarm	nonE	
<b>rLY3</b>	Alarm #3 Relay Action	ndE = Normally de-energized non-latching nE = Normally energized non-latching ndEL = Normally de-energized latching nEL = Normally energized latching	ndE	

See page 50 for details.

**Output #3 Page (continued)**

<u>MENU</u>	<u>Description</u>	<u>Available Settings</u>	<u>Factory Settings</u>	<u>Security</u>
<b>Al 3</b>	Alarm #3 Low Setpoint	Instrument Sensor Span	Span Low	C
<b>Al 3</b>	Alarm #3 High Setpoint	Instrument Sensor Span	Span High	
<b>db 3</b>	Output #3 Dead Band (Alarm Hysteresis)	0 to 100°F	1°F	
<b>inh 3</b>	Alarm #3 Inhibit	OFF On	OFF	

See page 51 for details.

**Output #4 Page**

<u>MENU</u>	<u>Description</u>	<u>Available Settings</u>	<u>Factory Settings</u>	<u>Security</u>
<b>EP 4</b>	Output #4 Type	OFF = Disabled Al r = Alarm Output En t = Event Output (Setup Event Output parameters on Ramp/Soak Page)	OFF	C
<b>Al r 4</b>	Alarm #4 Type	nonE = Disabled (off) Hi = High Alarm Lo = Low Alarm HiLo = High-Low Alarm PdE = Plus Deviation Alarm -dE = Minus Deviation Alarm dE = Plus/Minus Deviation Alarm Loop = Control Loop Protection Alarm	nonE	

## Output # 4 Page

See page 51 for details.

Output #4 Page (continued)				
MENU	Description	Available Settings	Factory Settings	Security
<b>rL44</b>	Alarm #4 Relay Action	ndE = Normally de-energized non-latching nE = Normally energized non-latching ndEL = Normally de-energized latching nEL = Normally energized latching	ndE	C
<b>Rd44</b>	Alarm #4 Low Setpoint	Instrument Sensor Span	Span Low	
<b>Rh44</b>	Alarm #4 High Setpoint	Instrument Sensor Span	Span High	
<b>db44</b>	Output #4 Dead Band (Alarm Hysteresis)	0 to 100°F	1°F	
<b>ri44</b>	Alarm #4 Inhibit	OFF On	OFF	

## Output # 5 Page

See page 52 for details.

Output #5 Page				
MENU	Description	Available Settings	Factory Settings	Security
<b>t4P5</b>	Output #5 Type	OFF = Disabled Ri r = Alarm Output EoE = Event Output (Setup Event Output parameters on Ramp/Soak Page)	OFF	C
<b>Ri r5</b>	Alarm #5 Type	nonE = Disabled (off) Hi = High Alarm Lo = Low Alarm HiLo = High-Low Alarm PdE = Plus Deviation Alarm -dE = Minus Deviation Alarm dE = Plus/Minus Deviation Alarm LoopP = Control Loop Protection Alarm	nonE	

See page 52 for details.

**Output #5 Page (continued)**

MENU	Description	Available Settings	Factory Settings	Security
<b>rL45</b>	Alarm #5 Relay Action	n̄dE = Normally de-energized non-latching nE = Normally energized non-latching n̄dEL = Normally de-energized latching nEL = Normally energized latching	n̄dE	C
<b>Roi 5</b>	Alarm #5 Low Setpoint	Instrument Sensor Span	Span Low	
<b>Rhi 5</b>	Alarm #5 High Setpoint	Instrument Sensor Span	Span High	
<b>db5</b>	Output #5 Dead Band (Alarm Hysteresis)	0 to 100°F 0.00 to 6.25% for analog input	1°F	
<b>nh5</b>	Alarm #5 Inhibit	OFF On	OFF	

See page 52 for details.

**Digital Communications Page: d9 PAGE**

MENU	Description	Available Settings	Factory Settings	Security
<b>d9t</b>	Mode Selection	OFF = Disabled CPiF = Computer Interface LinE = ASCII Line	CPiF	C
<b>bAud</b>	Baud Rate	1200 2400 4800 9600 19.2K	19.2K	
<b>Raddr</b>	Address	1 to 255	1	

## Display Page

The Display Page is for status only.  
None of the settings can be changed.

See page 34 for details.

### Display Page

<u>MENU</u>	<u>Description</u>	<u>Displays</u>	<u>Security</u>
<b>Proc</b>	Process Variable	Sensor Span	A
<b>RSP</b>	Active Setpoint	Sensor Span	
<b>Out1</b>	Output #1 Command	<b>0.0 to 100.0%</b>	
<b>Out2</b>	Output #2 Command	<b>0.0 to 100.0%</b>	
<b>rSP</b>	Remote Setpoint Input	Sensor Span	
<b>rS</b>	Ramp/Soak Status	<b>OFF</b> = Program not running <b>run</b> = Program running <b>Hold</b> = Program in hold <b>Stby</b> = Program in standby <b>9S</b> = Guaranteed soak	
<b>int</b>	Ramp/Soak Interval Number	<b>0 - 16</b>	
<b>LEft</b>	Ramp/Soak Time Left in Interval	<b>0.0 to 999.9</b> hr/min/sec	
<b>LoOP</b>	Ramp/Soak Loops Remaining	<b>0 - 9999</b>	
<b>Al r</b>	Alarm Output Status	<b>None</b> = No alarms <b>A3</b> = Alarm Output #3 <b>A4</b> = Alarm Output #4 <b>A43</b> = Alarm Outputs #4 and #3 <b>A5</b> = Alarm Output #5 <b>A53</b> = Alarm Outputs #5 and #3 <b>A54</b> = Alarm Outputs #5 and #4 <b>A543</b> = Alarms 5, 4 and 3	
<b>Ent</b>	Event Output Status	<b>None</b> = All off <b>E3</b> = Event Output #3 <b>E4</b> = Event Output #4 <b>E43</b> = Event Outputs #4 and #3 <b>E5</b> = Event Output #5 <b>E53</b> = Event Outputs #5 and #3 <b>E54</b> = Event Outputs #5 and #4 <b>E543</b> = Events 5, 4 and 3	

## Index

- Accuracy 7, 8, 81, 85
- Alarm Inhibit 48, 50, 51, 52, 83
- Alarm Operation 49
- Alarm Outputs 34, 47, 51, 83
- Alarms
  - Control Loop Protection (see Control Loop Protection Alarm)
  - Latch/Non-Latching 49-52, 63, 83
  - Low Alarm 1, 41, 50-52
  - Reset 22, 49
  - Wiring 19-20
- Analog Output Option 2, 67-70, 80, 85
- Applications 1, 29, 61, 82
- Auto/Manual 10, 22, 36, 37, 59, 60, 63, 65
- Auto Tuning, see Self-Tuning
  
- Calibration 75-82
- Calibration
  - Analog Output 80
  - Factory Recovery 81
  - Offset 38, 82
  - Remote Setpoint Input 78
  - Security Codes 26
  - Sensor Input 76
- ChromaSoft 1, 45, 71
- Control Loop Protection Alarm (CLP) 50-57
- Control Parameters 23, 26, 28
- Control Programming 21-22, 24-25
- Cycle Time 39, 83
  
- Digital Communications 1, 2, 71-74
  - Hardware Setup 71-72
  - Programming 74
  - Wiring 72-73
- Digital Input 1, 7, 30, 31, 35, 36, 45, 49, 59-63, 67, 85
- Dimensions 5, 85
- Dip Switches 3
  - Analog Output 69
  - Digital Communications 72
  - Remote Setpoint 67
  - Sensor Input 4
- Displays 21-25, 34, 35, 56, 57, 87-88
- Display Mode, Normal 21, 22, 44-46
  
- Error Messages 87-88

Fuzzy Logic 30, 36

Indications 21

Input Type 4, 36

Inputs, Sensor 1, 8-10, 76

Installation 3

Jumpers, Output 11-14, 17

Manual Operation 31, 63, 65

Menu Selection 24

Model Identification 2

Mounting 4-5

Operation 21-31

Alarm 49

Auto/Manual 63, 65

Control 28-31

Erratic 87

Manual 31

Ramp/Soak 10, 41-45, 62

Output #1 1, 11-14, 16-18, 22, 28, 33-35, 39, 69, 70, 85

Output #2 1, 11, 14, 16-18, 22, 28, 33-35, 39, 69, 70, 85

Output #3 7, 19, 23, 34, 41, 43, 47-50, 54-57

Output #4 1, 7, 19, 23, 34, 41, 43, 48, 49, 55-57

Output #5 7, 20, 23, 34, 41, 43, 47-49, 52, 55-57, 61, 63, 83

Output, Analog 69-70

Output, Alarm Relays 49-52

Output Wiring 6, 11, 13, 15-18, 70, 87

## PAGE

Control 26, 28, 35-37

Custom Scaling 39, 68

Digital Communications 74 (see Digital Communications in this index)

Display 26, 34 (see Display and Displays in this index)

Input 38

Output #1 39 (see Output #1 in this index)

Output #2 39 (see Output #2 in this index)

Output #3 50 (see Output #3 in this index)

Output #4 51 (see Output #4 in this index)

Output #5 52 (see Output #5 in this index)

Ramp/Soak 43 (see Ramp/Soak in this index)

PID1 22, 28, 29, 35, 59-61

PID2 22, 28, 29, 35-37, 59-61

Pushbuttons 21-31

- Ramp/Soak 10, 26, 28, 31, 33, 34, 36, 37, 50-52, 59-64
  - Operation 22, 41-45
  - Programming 41-42, 44-45, 84
- Ramp to Setpoint 28, 30
- Remote Setpoint 3, 22, 30, 36, 59-61, 64, 78-79, 84
- Repair 89-90
- Reset Pushbutton 22, 24, 49
- RTD Inputs 76
  - Calibration 76
  - Wiring 8-9
  
- Security Codes 26, 27, 35
- Security Levels 26, 27
- Self-Tuning 29, 88
- Sensor
  - Setup, Menu 38
  - Wiring 7-10, 56, 87
- Setpoint
  - Ramp 28, 30
  - Remote (see Remote Setpoint in this index)
- Setup Mode 22, 24, 27
- Specifications 83-86
  
- Thermocouple Inputs 8, 76
- Timer
  - Loop 36, 53, 55-57
- Troubleshooting 87-88
- Tuning
  - Self (see Self-Tuning in this index)

## Warranty 89-90

### Wiring

Alarm 19-20

Current Input Wiring (Loop Powered by Controller) 10

Current Input Wiring (Self powered) 9

Digital Communications 72-73

Digital Input 10

Dual Analog Output Wiring 16

Dual Output Analog/Relay Wiring 18

Dual Output Analog/Triac Wiring 18

Dual Output SSR/Relay Wiring 17

Dual Output SSR Triac Wiring 17

Dual Relay Output Wiring 16

Dual SSR Drive Output Wiring 16

Dual Triac Output Wiring 16

Dual 1-5 Vdc Output Wiring 17

Good Wiring Practices 6

Heat/Cool Output 16-18

Instrument Power 19

Output 16-17, 48

Remote Setpoint 68

RS232 Wiring Connections 72

RS422A Wiring Connections (4-wire) 73

RS485 Wiring Connections (2-wire) 73

Sensor (see Sensor Wiring in this index)

Terminal Identification 7

Voltage Input Wiring (Self-powered) 10

# **Chromalox<sup>®</sup>**

**INSTRUMENTS AND CONTROLS**  
1382 HEIL QUAKER BOULEVARD  
LAVERGNE, TN 37086-3536

PHONE (615) 793-3900  
FAX (615) 793-3563

**WIEGAND INDUSTRIAL DIVISION**  
EMERSON ELECTRIC CO.

